

## WELDING MACHINES

**aXe 250 PULSE** *mobíl* **(AL)**  
**GAS**

**aXe 320 PULSE** *mobíl* **(AL)**  
**GAS**

**aXe 250** *mobíl* **GAS**

**aXe 320** *mobíl* **GAS**

## INSTRUCTION MANUAL

**CONTENT**

<b>1. INTRODUCTION .....</b>	<b>3</b>
<b>2. SAFETY PRECAUTIONS .....</b>	<b>4</b>
<b>3. OPERATING CONDITIONS.....</b>	<b>5</b>
<b>4. TECHNICAL DATA .....</b>	<b>6</b>
<b>5. ACCESSORIES .....</b>	<b>8</b>
<b>6. DESCRIPTION OF THE APPLIANCE.....</b>	<b>9</b>
<b>7. BASIC SETTINGS .....</b>	<b>15</b>
<b>8. MIG/MAG WELDING SYNERGY .....</b>	<b>22</b>
<b>9. PULSED MODE .....</b>	<b>23</b>
<b>10. MIG/MAG WELDING MANUAL.....</b>	<b>24</b>
<b>11. MMA WELDING (COATED ELECTRODE- ELE) .....</b>	<b>26</b>
<b>12. ROUTINE MAINTENANCE &amp; INSPECTION.....</b>	<b>26</b>
<b>13. STATEMENT OF WARRANTY.....</b>	<b>29</b>
<b>14. DISPOSAL.....</b>	<b>30</b>
<b>15. WARRANTY LIST.....</b>	<b>30</b>

# 1. INTRODUCTION

Dear Consumers!

Company ALFA IN a.s. thanks you for buying our product and believe that you will be satisfied with our machine.

Welding machines aXe 250 PULSE MOBIL (AL) GAS and aXe 320 PULSE MOBIL (AL) GAS/H<sub>2</sub>O are IGBT invertors. They are designed for welding method MMA, MIG (Metal Inert gas) and MAG (Metal Active Gas). This is welding in protective atmosphere (methods MIG, MAG). We are using inert (impassive) and active gases during welding. These methods are very productive and particularly suitable for the connections of structural steels.

With welding machines aXe 250 PULSE MOBIL (AL) GAS and aXe 320 PULSE MOBIL (AL) GAS/H<sub>2</sub>O it is possible to weld different types of connections (blunt, single-sided, double-sided, fillet, lap etc.) using wire diameter from 0,6 – 0,8 mm, or 1,0 – 1,2 mm of different metals and alloys (carbon and alloy steels, aluminum alloys etc.).

Welding machines aXe 250 MOBIL GAS and aXe 320 MOBIL GAS haven't pulsed mode. But it is possible to extend these machines about pulsed mode.

Welding machines aXe 250 MOBIL GAS and aXe 320 MOBIL GAS haven't welding method MMA. But it is possible to extend these machines about welding method MMA.

**S** The machines can be used for welding in areas with increased danger of electric shock. Machines comply with the relevant requirements for CE marking.

We reserve the law of adjustments and changes in case of printing errors, change of technical paramaters, accessories etc. without previous notice. These changes may not be reflected in the manuals for use in paper or electronic form.



## 2. SAFETY PRECAUTIONS

### PERSONAL PROTECTION

1. For safety reasons, it is necessary to use welding gloves during welding. These gloves will protect you before intervention of electric current (open circuit voltage). It protects you against thermal radiation and splashing drops of hot metal too. Wear sturdy isolated shoes. Do not wear open shoes, because drops of hot metal can cause burns.
2. Do not look into the welding arc without eye and face protection. Always use good quality welding helmet with intact protective filter.
3. The persons appearing in the vicinity of the welding must be informed of the danger and must be equipped with protective equipment.
4. During welding, especially in small spaces, it is necessary to ensure an adequate supply of fresh air, because during welding, harmful fumes arise.
5. In tanks of gas, oil, fuel, etc., (even empty ones) do not make welding, because there is a chance of explosion.
6. In areas with chance of explosion special provisions are applied.
7. Welding machines that are subjected to great exertion must comply with specific security requirements. These include the rail pressure of the vessel etc. These connections may only be carried out by competently trained welders with the necessary permissions.

### SAFETY REGULATIONS

1. Before starting work with welding machine it is necessary to get familiar with the provisions of the ČSN 050601 and norm ČSN 050630.
2. With a bottle of CO<sub>2</sub> or mixed gases should be handled according to the regulations for working with pressure vessels contained in ČSN 07 83 05 and norm ČSN 07 85 09.
3. The welder must use protective equipment.
4. Before working on the electrical part, removing the cover or cleaning it is necessary to disconnect the device from the network.

### 3. OPERATING CONDITIONS

1. Putting the machine into operation can be performed only by trained personnel and only within the technical provisions. The manufacturer is not liable for damages resulting from improper use or handling. For maintenance and repair, use only original spare parts from ALFA IN.
2. Device complies with IEC 61000-3-12 with following conditions: Short-circuit power  $S_{sc}$  of network in place at an interface between the user's supply and the public network (PCC) must be least 4106 kW. User is obliged to consult with the electricity supplier if the impedance of the network at this point is that required short-circuit capacity  $Z_{max} = 36 \text{ m}\Omega$  and whether the device can be connected with a public low-voltage network.

On the nameplate are the following symbols: .

3. The welding machine is tested according to the degree of protection IP 23S, which provides protection against the intrusion of solid bodies with a diameter greater than 12 mm and protection against ingress of water, falling on the machine in a vertical direction or max degree of 60°.
4. Working ambient temperature between -10 and +40 °C.
5. Relative humidity below 90% at +20 °C.
6. Up to 3000 m altitude.
7. The machine must be positioned so that cooling air can enter and leave through cooling vents with no problem. It is necessary to ensure that there are no mechanical equipment, especially metal particles (e.g. during grinding) drawn into the machine.
8. Handling handle is intended for movement, it is not designed to lifting the machine.
9. In case of overheating of the machine welding is automatically stopped and this condition is signaled by pilot light.
10. All interventions in the el. equipment as well as repair (removal of the plug, fuse replacement) should be performed by an authorized person.
11. With competent mains voltage and input must match the plug.
12. Do not use the machine for other purposes, such as defrosting pipes, starter source, etc.
13. It is necessary for welding machine to undergo a periodic inspection every 6/12 months by an authorized officer according to ČSN 331500 and ČSN 050630 – see Maintenance and service tests.
14. The welding machine is designed especially for industrial areas. In case of using it in other areas there may exist special measures (see EN 60974-10).
15. It is necessary to protect the machine against:
  - a. Moisture and rain
  - b. Mechanical damage
  - c. Draft and possibly ventilation of neighboring machines
  - d. Excessive overloading – exceeding tech. parameters

- e. Rough treatment
- f. Chemically aggressive environments

## ELECTROMAGNETIC COMPATIBILITY

The welding device is in terms of interference designed primarily for industrial areas. It meets the requirements of EN 60974-10 class A and it isn't designed for using in residential areas, where the electrical energy is supplied by public low-voltage power supply network. It can be here potential problems with ensuring of electromagnetic compatibility in this areas, due to interference caused by power lines as well as the radiated interference.

During operation, the device may be the source of interference.

 Caution 

We warn users, that they are responsible for possible interference from welding.

## 4. TECHNICAL DATA

Model		<b>aXe 250 PULSE MOBIL (AL) GAS</b>	
Method		MIG/MAG	MMA
Mains voltage	V/Hz	3x400/50-60	
Welding current range	A	20 - 250	10 - 250
Open-circuit voltage U <sub>20</sub>	V	63,1	
Mains protection	A	16 @	
Max. effective current I <sub>1eff</sub>	A	12,9	13,0
Welding current (DZ=100%) I <sub>2</sub>	A	210	190
Welding current (DZ=60%) I <sub>2</sub>	A	250	230
Welding current (DZ=x%) I <sub>2</sub>	A	60%=250	50%=250
Protection		IP 23S	
Standards		EN 60974-1, EN 60974-10 cl. A	
Dimensions (w x l x h) generator	mm	240 x 650 x 438	
Weight - generator /compact	kg	26,6	
Wire speed	m/min	1,0 - 16,0	---
Spool diameter	mm	300	---
Spool weight	kg	18	---

Model		<b>aXe 320 PULSE MOBIL (AL) GAS</b>	
Method		MIG/MAG	MMA
Mains voltage	V/Hz	3 x 400/50-60	
Welding current range	A	20 - 315	10 - 300
Open-circuit voltage U <sub>20</sub>	V	63,1	
Mains protection	A	16 @	
Max. effective current I <sub>1eff</sub>	A	12,9	12,8
Welding current (DZ=100%) I <sub>2</sub>	A	210	190
Welding current (DZ=60%) I <sub>2</sub>	A	250	230
Welding current (DZ=x%) I <sub>2</sub>	A	25%=315	20%=300
Protection		IP 23S	
Standards		EN 60974-1; EN 60974-10 cl. A	
Dimensions (w x l x h) generator	mm	240 x 650 x 438	
Weight - generator /compact	kg	26,6	
Wire speed	m/min	1,0 - 16,0	---
Spool diameter	mm	300	---
Spool weight	kg	18	---

 The machine marked with this symbol can be used for welding in areas with an increased risk of electric shock. The machine structure is designed so that, in any case, even if the failure rectifier does not exceed the permitted peak value of the open circuit voltage according to EN 60974-1, i.e., 113 V direct current or 68 V alternating.



## 5. ACCESSORIES

### PART OF DELIVERY

1. Roll (rolls) for wire with diameters 0,8 – 1,0 mm
2. Instruction manual
3. Reducing for the spool wire 5 kg and 15 kg
4. Earthing cable 3 m with clamp
5. Hose for gas connection

### ACCESSORIES ON REQUEST

1. Pressure regulator
2. Spare parts for torch
3. Rolls 0,6-0,8 and 1,0-1,2 with different grooves
4. Torch PARKER SGA-LW305A Ultralight 3 m – 5 m
5. Torch PARKER DIGIMIG 305 aXe IN UD Ultralight 3 m – 5 m
6. Torch PARKER SGB 240W délka 3 m – 5 m
7. Torch PARKER DIGIMIG 240W aXe IN UD 3 m – 5 m
8. Set for aluminium welding
9. Wire cleaner

 **NOTICE**  If you decide to use a different torch than the above, it is necessary to choose one, according to your current range and load time of the torch. ALFA IN a.s. is not liable for damage caused by overload welding torches.



## 6. DESCRIPTION OF THE APPLIANCE

### MAIN PARTS

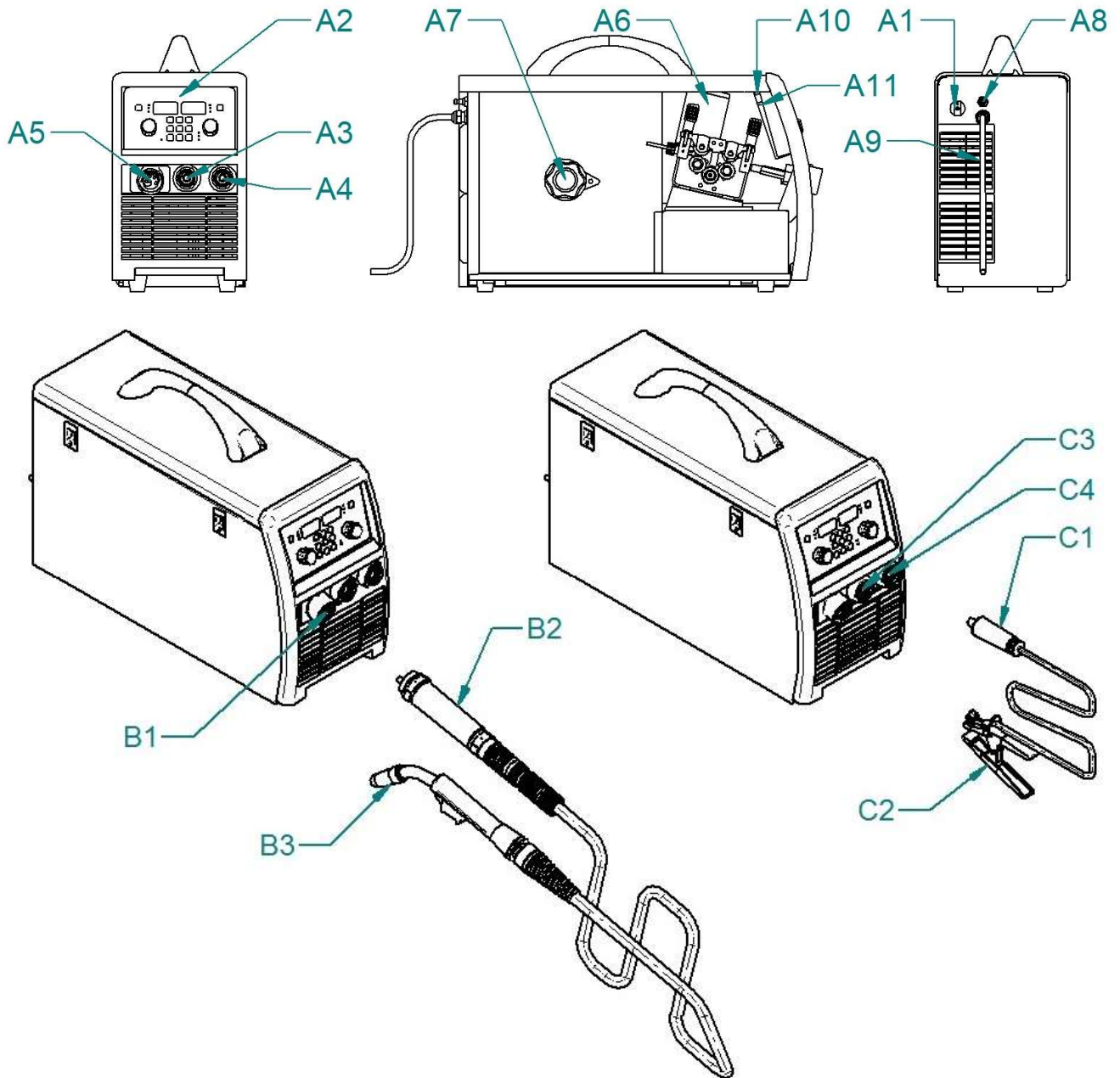

Fig. 1 – Main parts of the machine

Pos.	Description
A1	ON/OFF switch
A2	PCB control panel
A3	Quick connector (+)
A4	Quick connector (-)
A5	EURO connector
A6	Wire feeder
A7	Spool holder
A8	Soneloid valve
A9	Mains cable
A10	Button of inserting the wire
A11	LED
B1	EURO connector
B2	EURO connector male
B3	Torch
C1	Quick connector male
C2	Earthing clamps
C3	Quick connector (+)
C4	Quick connector (-)

## WIRE FEEDER

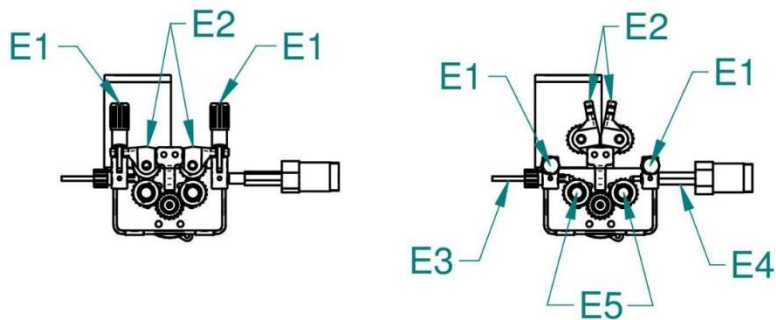

Fig. 2 – Wire feeder 4 rolls

Pos.	Description
E1	Nut of pressure arm
E2	Pressure arm
E3	Inlet liner
E4	EURO connector
E5	Roll

## CHOOSING THE FEEDING ROLL

In all machines ALFA IN MIG / MAG rolls with two grooves are used. These grooves are intended for two different wire diameters (e.g. 0,8 and 1,0 mm).

Rolls for wire feed must comply with the diameter and material of the welding wire. Only this way a smooth wire feed can be achieved. Irregularities of the wire feed leads to a poor quality of welding and deformation of the wire.

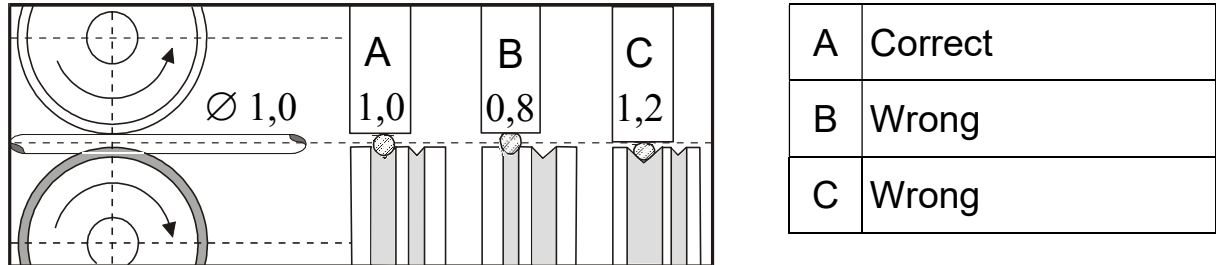
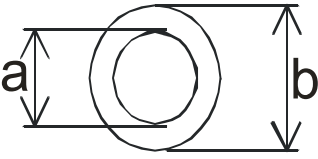
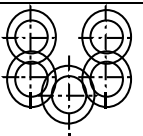

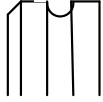
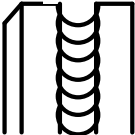

Fig. 3 - The influence of the roll groove on the welding wire

## OVERVIEW OF ROLLS FOR WIRE FEED

		4 rolls	
			
		a = 10 mm	
		b = 30 mm	
Groove type	Wire diameter	Item No	
<b>Steel</b> 	0,6-0,8	5434	
	0,8-1,0	5435	
	1,0-1,2	5436	
<b>Aluminum</b> 	0,8-1,0	5437	
	1,0-1,2	5438	
<b>Flux core</b> 	0,8-1,0	5439	
	1,0-1,2	5440	
	1,2-1,4	5441	

## ADJUSTING THE MACHINE FOR ANOTHER WIRE DIAMETER

In all machines ALFA IN MIG / MAG are used rolls with two grooves. These grooves are intended for two different wire diameters (e.g. 0,8 a 1,0 mm). Groove can be replaced by removing the rolls and rotating them, or use a different roll grooves with required dimensions.

1. Open the nut **E1** to the forward, pressure rolls **E2** will be opened upward.
2. Unscrew the locking element and remove the roll.
3. If there is a suitable groove on the roll, rotate the roll and place it back on the shaft and secure it by screwing the element.

## ADJUSTING THE MACHINE FOR WELDING OF ALUMINIUM

For feeding the AL wire it is necessary to use roll with the “U” profile - see paragraph OVERVIEW OF ROLLS FOR WIRE FEED. To prevent problems with feeding use wires with diameter 1,0 mm of AlMg3 or AlMg. Wire of alloy Al99, 5 or AlSi5 are too soft and easily will cause problems with movement.

For the aluminum welding it is also necessary to provide the torch tefl. liner and special current nipple. We do not recommend you to use the torch longer than 3 m. Great attention must be paid to adjust the contact power of rolls – it must not be too high, otherwise there is a deformation of the wire.

As a protective atmosphere is necessary to use argon.

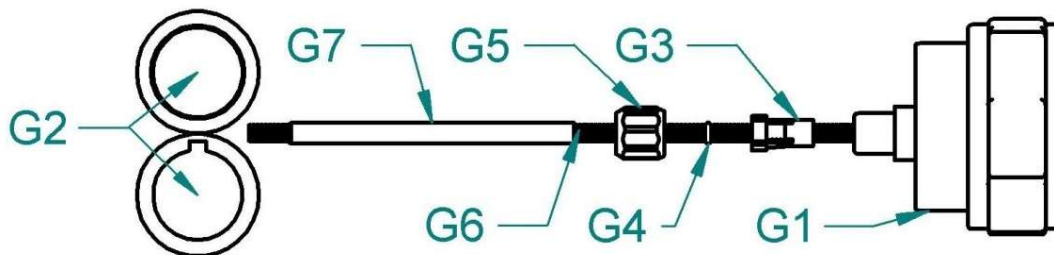

Fig. 4 – Customization of the feed for the aluminium wire

Pos.	Description
G1	EURO connector
G2	Rolls
G3	Liner terminal for 4,0mm, 4,7mm outer diameter
G4	O-ring 3,5 x1, 5mm to prevent escape of gas
G5	Nut
G6	Liner tefl.
G7	Sustain pipe for teflon and plastic liner

## INSERTING THE WIRE

1. Open the side cover of the wire feeder space.
2. Put the wire spool on the wire spool holder **D1** and fix it with the fixing nut **D2**. If a spool (size of 15 or 18 kg) is used, put on each side of the spool adapter **D3**. The hole in the back of the adapter must fit into the pin on the wire spool holder!

3. Cut off the curved or damaged end of welding wire and lead it through the inlet liner **E3**, and the roll into the liner inside the EURO torch connector (about 5 cm). Make sure, that you use the suitable groove.
4. Put the pressure arm **E2** down in that way, that the teeth or the gear fit and fix it by setting the lever **E1** into vertical position.
5. Adjust the pressure nut that way that it provides constant movement of wire but it does not deform wire. By pressing the button **A10**, placed in the space of the wire feeder, turn on the motor of the feeder. The adjusting screw is located under the plastic screws **E1**.
6. The spool brake is set by the manufacturer. If necessary, the brake can be adjusted by a screw **D1** so that while stopping the feed, spool will be stopped on time (it will avoid excessive release of wire). However, too tight brake needlessly strains the feeding mechanism and thus slippage may occur in the wire rolls.

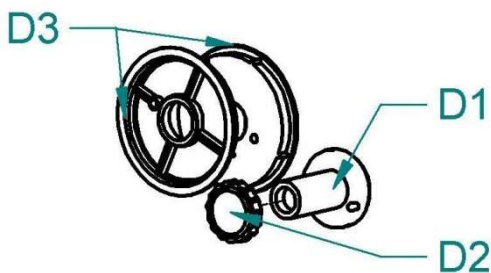

Pos.	Description
D1	Spool Holder
D2	Nut Spool Holder
D3	Adapter

Fig. 5 - Spool holder

## ADJUSTING PRESSURE FORCE OF FEED ROLLS



Important thing for reliable operation of the feeding mechanism is the size of pressure force of feed rolls.

The amount of force depends on the type of welding wire, for aluminum or tube wire, we choose a smaller pressure force.

If the pressure force is too small, slippage may occur and thus irregular wire feeding speed.



If the pressure force is too high, it will lead to increased mechanical wear of bearings and it can damage the machine. Before putting into operation, clean the rolls from preservative oil.

## INSERTING THE WIRE TO THE TORCH AND CONNECTION OF EARTH CABLE

1. Connect the earthing clamps to the welder or to the welding table.
2.  Notice  When inserting the wire do not point with torch to the eyes!
3. Screw the central end of the torch **B2** to connector **B1** on the machine while the machine is turned off.
4. Remove the gas nozzle from the torch.
5. Unscrew the current nozzle.
6. Connect the machine to power supply.
7. Turn the ON/OFF switch to ON.
8. Press button **A10** in the space of wire feeder to run the motor of the feeder. The welding wire is fed into the torch. After coming off from the torch tube, screw the current nozzle and gas nozzle on.
9. Before welding, spray the area in a gas hose and current nozzle with a separation spray, to prevent damage.

## ADJUSTMENT OF GAS FLOW

The electric arc and the weld must be perfectly shielded by gas. Too small amount of gas does not perform the protective atmosphere and on the other hand to big amount of the gas brings air into the electric arc.

 **Notice**  Gas bottle must be well secured against fall. This manual does not solve the safe securing of gas bottle. Information can be obtained from a supplier of industrial gases.

1. Fit the gas hose to the outlet on the back panel of the machine.
2. Press button **V1** (pic. 7) on the main panel to the switching of the gas valve. If you hold the button for less than 3 s, after releasing the button, the gas valve will turn off. If you hold the button for more than 3 s, it will turn off the gas valve after about 20 s, or after pressing any button.
3. Turn the adjusting screw **F7** at the bottom side pressure reducing valve, until the meter **F6** shows the required flow, then release the button. The optimum flow is 10-15l/min.
4. After long-term shutdown of the machine or replacement of the torch it is suitable to blow the pipes with protective gas before welding.

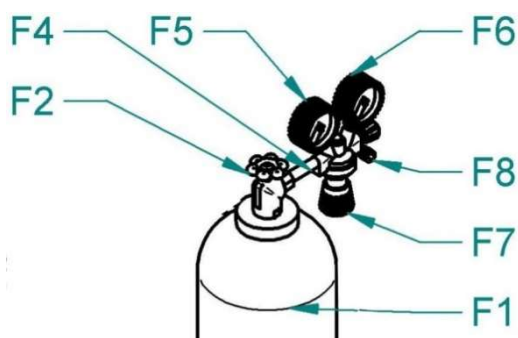

Fig. 6 – Gas flow setting

Pos.	Description
F1	Gas bottle
F2	Cylinder Valve
F4	Pressure Reducer
F5	High Pressure Manometer
F6	Low Pressure Manometer
F7	Adjusting Screw
F8	Gas outlet

## 7. BASIC SETTINGS

### CONTROL PANEL

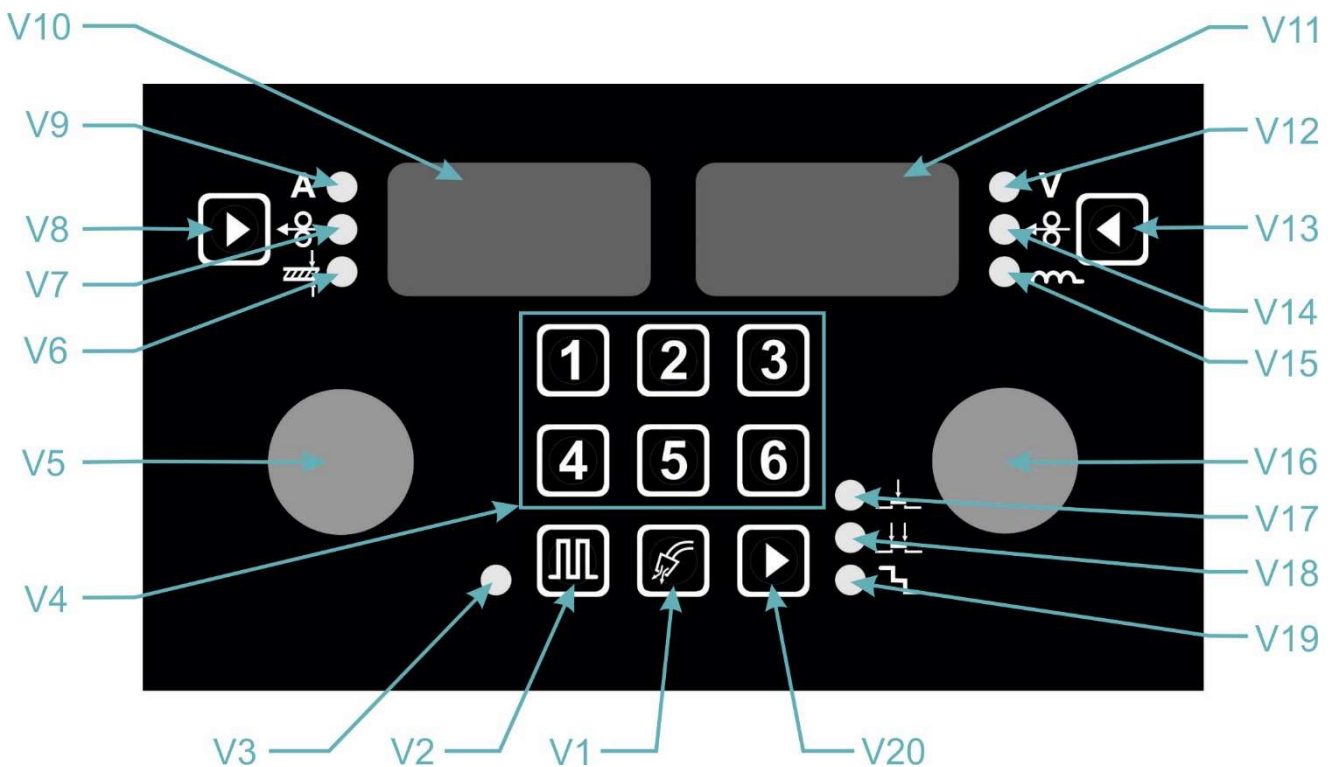

Fig. 7 – Control panel

Pos.	Description
V1	Button: Gas test
V2	Button: Pulsed mode
V3	LED - If it illuminates, when Pulsed mode was chosen
V4	Instant JOB buttons 1-6
V5	Current encoder
V6	LED - Material thickness (mm)
V7	LED - Wire speed (m/min)
V8	Button for selecting the parameters to be displayed
V9	LED - Current (A)
V10	Left display shows: 1. Welding current 2. Welding current in the MMA mode

	3. Speed of the wire 4. Material thickness 5. Sign of the secondary parameter
V11	Right display shows: 1. Welding voltage 2. Correction 3. Choke
V12	LED - Voltage or voltage correction
V13	Button for selecting the parameters to be displayed
V14	LED - Wire speed correction
V15	LED - Choke or choke correction
V16	Encoder voltage or correction
V17	LED - Two stroke – 2T
V18	LED - Four stroke – 4T
V19	LED - Stairs mode
V20	Button for selecting the parameters: 2T / 4T / Stairs

## SETTING THE METHOD OF WELDING

1. By long-pressing the encoder **V5** open the menu.
2. By turning the encoder **V5** choose the method ELE (covered electrode MMA), MAN (MIG/MAG manual) or SYN (MIG/MAG synergistic). Confirm your choice by pressing the button **V5**.

## WELDING METHOD SYNERGY

Synergic curves are welded in PB position (fillet connection, horizontal, obliquely from above). It is necessary to perform the parameters correction for welding in other positions.

AXE 250-320 PULSE MOBIL (AL)		ø 0.8	ø 1.0	ø 1.2
SG/Fe	Ar 82 % CO <sub>2</sub> 18 %	0 *	1 *	2 *
SG/Fe	Ar 92 % CO <sub>2</sub> 8 %	3 *	4 *	5 *
SG/Fe	CO <sub>2</sub> 100 %	6	7	8
Cr/Ni 308	Ar 97,5 % CO <sub>2</sub> 2,5 %	9 *	10 *	11 *
Cr/Ni 316	Ar 97,5 % CO <sub>2</sub> 2,5 %	12 *	13 *	14 *
CuSi 3	Ar 100 %	15 *	x	x
AlMg	Ar 100 %	x	16 **	17 **
AlSi	Ar 100 %	x	18 **	19 **

Table of synergic parameters

\* You can switch on/off the pulsed mode by means of the button **V2**.

\*\* Can be welded only in the pulsed mode, and it is available only for AL variant of the machine.



1. Left display **V10** shows SYN, right display **V11** shows the number of synergistic curve.
2. Selects the synergic curve (program number) using the encoder **V16** according to the table, which is located inside. To confirm the program number press the encoder **V5**.
3. If you press any button other than **V5**, or after 10 s, you exit the menu.

## CALIBRATION OF THE WELDING CIRCUIT

Welding features of the synergic curve depends on many factors, for example: on the torch length, ground cable length, grounding quality, weldment distance from the grounding place etc. Therefore, it is appropriate to perform the calibration of the welding circuit for actual welding conditions.

1. Simultaneously press **V20** and **V5** encoder and you will enter the menu for secondary parameters.
2. Choose CAL parameter by the encoder **V5** and press it to confirm.
3. Set CrE by the encoder **V5** and press it to confirm.
4. Unscrew the gas nozzle of the welding torch.
5. Cut off the welding wire tightly at the welding jet.
6. Piece of the welding wire (about 50 mm) give to the wire feeder. In the current jet cannot be now any welding wire.
7. Place the welding tip of welding torch on a clean or cleaned place of the workpiece by the gentle pressure, press and hold the torch button for 2 s. For a moment flows the short-circuit current. Short-circuit current helps to determine and screen the new resistance. (Value can be from 0 mΩ to 60 mΩ – for users aren't these values important, factory reset CrE = 10 mΩ, you can set this value by the encoder **V16**).
8. Right display **V11** shows **Err**, if an error occurs. You must repeat the measurement.
9. Screw back the gas nozzle of the welding torch.
10. Insert the welding wire.



## QUICK SETTING THE JOB - MEMORY

Works for all welding methods.

1. Long press (4s) one of the buttons **V4** (1,2,3,4,5,6) to save set parameters to memory. JOBs are stored as active (they can be switched by remote control on the burner).
2. Short press one of the buttons **V4** (1,2,3,4,5,6) to load parameters from memory.
3. Display shows **no Job**, if at the desired position isn't saved any JOB.



## WELDING MODE 2T – TWO STROKE

Works for both welding methods MIG/MAG.

Press the button **V20** to switch between the modes **2T** , **4T**  and . The two stroke mode is signaled by LED **V17**. First tact: press and hold the torch button, the machine will start welding. Second tact: release the torch button, the machine will stop welding.



## WELDING MODE 4T – FOUR STROKE

Works for both welding methods MIG/MAG.

Press the button **V20** to switch between the modes **2T** , **4T**  and . The four stroke mode is signaled by LED **V18**. First tact: press and hold the torch button, the machine will start welding. Second tact: release the torch button, the machine will continue welding. Third tact: press the torch button, the machine will continue welding. Fourth tact: release the torch button, the machine will stop welding.

## WELDING MODE 2T – TWO STROKE STAIRS



Works for both welding methods MIG/MAG.

Press the button **V20** to switch between the modes **2T** , **4T**  and . The two stroke stairs mode is signaled by LEDs **V17** and **V19**.

First tact: press and hold the torch button, the machine will start welding with the Start current **SCu** during the time **START t S**. Then after the time **UP tuP** start the machine welding with the main welding current (100 %). Second tact: release the torch button, after the time **DOWN tdo** start the machine welding with the End current **ECu** during the time **END t E**. After this time the machine will stop welding.

## WELDING MODE 4T – FOUR STROKE STAIRS

Works for both welding methods MIG/MAG.

Press the button **V20** to switch between the modes **2T** , **4T**  and . The four stroke mode is signaled by LEDs **V18** and **V19**.

First tact: press and hold the torch button, the machine will start welding with the Start current **SCu**. Second tact: release the torch button, after the time **UP tuP** start the machine welding with the main welding current (100 %). Third tact: press the torch button, after the time **DOWN tdo** start the machine welding with the End current **ECu**. Fourth tact: release the torch button, the machine will stop welding.

## BILEVEL BCU ≠ 100 %

The difference of BILEVEL compared with classical stairs is in the second tact. When you quickly press and release the torch button, the machine switches between two set main welding currents.

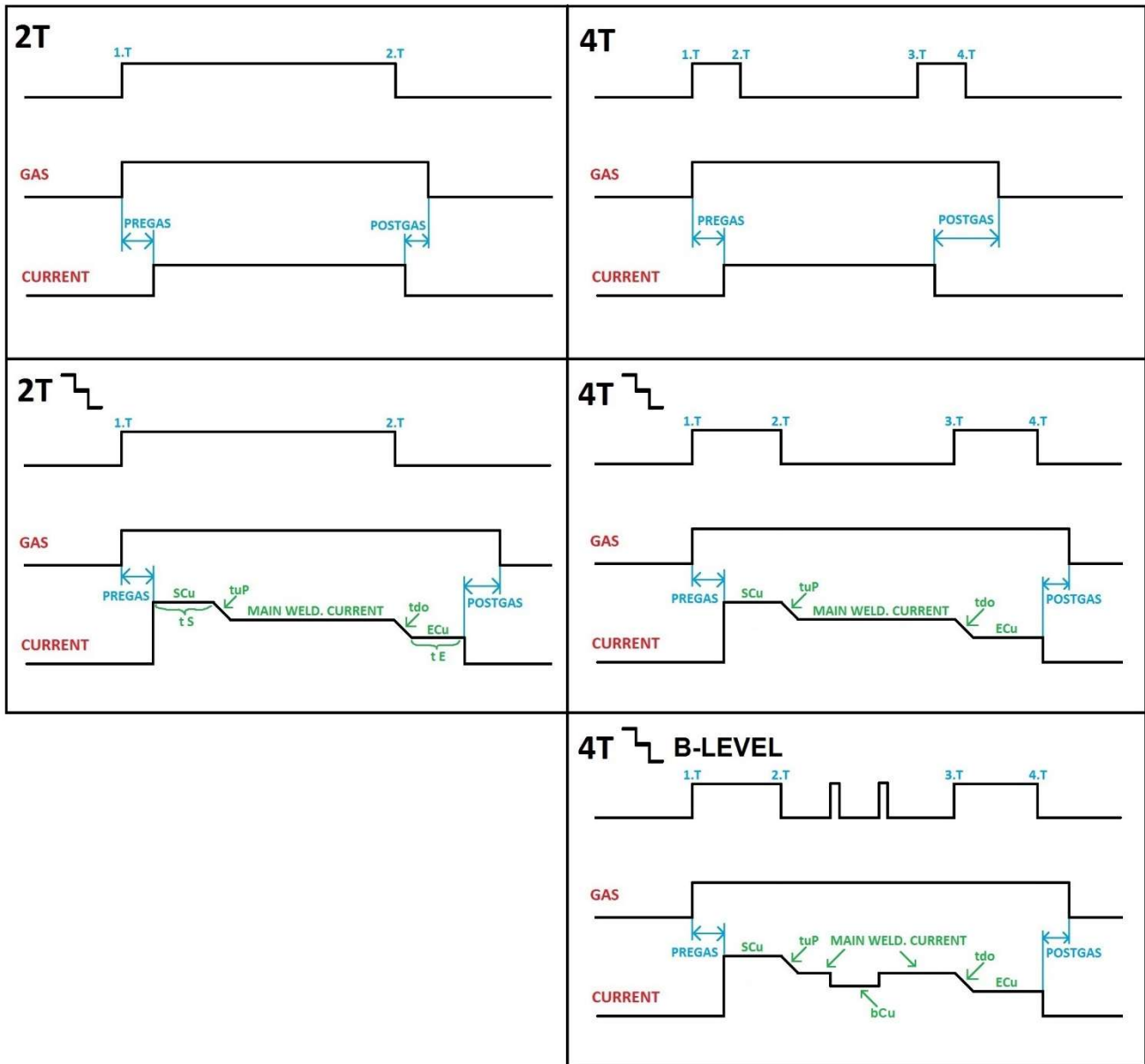

Fig. 8 – Curves of modes

## SECONDARY PARAMETERS MENU

From start the welding machine is set to factory settings (default). For most of the work it is not appropriate to change the secondary parameters. Secondary parameters for manual and synergistic methods are identical.

1. Simultaneously pressing **V20** and **V5** encoder enters the menu for secondary parameters.
2. Encoder **A5** selects a parameter (ISP, PRG, PoG, brn), **V16** encoder sets the desired value.

3. Press the encoder **V5** to confirm the change.
4. Press any button, or after 10 s, to exit the menu without saving changes.
5. Secondary parameters are common for methods manual and synergy. Synergy method allows to set more secondary parameters.

Symbol	Meaning	Range (Default)	Mark
<b>ISP</b> (Initial speed)	Approaching speed	10 - 100 % (30 %)	
<b>PrG</b> (Pre gas time)	Pre gas	0 - 20 s (0,1 s)	
<b>PoG</b> (Post gas time)	Post gas	0 - 20 s (0,5 s)	
<b>brn</b> (Burn back)	Burn back	0 - 150 ms (50 ms)	
<b>SCu</b> (Start current)	Start current	10 - 200 % (130 %)	2, 4
<b>bCu</b> (Bilevel current)	Second current	10 - 200 % (100 % = turned off)	2, 4
<b>ECu</b> (End current)	End current	10 - 200 % (70 %)	2, 4
<b>tuP</b> (Time UP)	Time up	0,1 - 10,0 s (0,1 s)	2, 4
<b>t do</b> (Time DOWN)	Time down	0,1 - 10,0 s (0,1 s)	2, 4
<b>t S</b> (Time START)	Time of start current	0,1 - 10,0 s (0,1 s)	2
<b>t E</b> (Time END)	Time of end current	0,1 - 10,0 s (0,1 s)	2
<b>CAL</b> (Calibration menu)	Calibration menu	x.xx (version sw PCB engine)	(*)

The last menu item is **CAL** – it is used to enter the calibration menu, which is intended only for authorized service.

Parameters marked as 2 are available only in 2T stairs mode. Parameters marked as 4 are available only in 4T stairs mode.

## WELDING HOURS COUNTER

If you enter to secondary parameters menu, you can always display this value. By long-pressing the button **V4 (1)** will be displayed the welding time in hours.

## CALIBRATION MENU

u-l	Calibration of voltage and current (password protected - intended for authorized service)
Cu1	Cooling unit oFF/on/Aut
Cu2	Sensor settings 0 – service mode 1 – pressure switch / flow sensor 2 - flow sensor with propeller password protected - for authorized service
Cor	Zeroing of the correction (YES = zeroing of the correction when is changed the output value in the synergic mode)
CrE	See CALIBRATION OF THE WELDING CIRCUIT

By long-pressing the button **V4 (1)** perform the display test.

By long-pressing the button **V4 (2)** display the machine variant / roll size (only for machines with speed measurement) (37 – AXE 250/320 PULSE SMART, 30 – AXE 250/320 PULSE MOBIL).

## REMOTE CONTROL

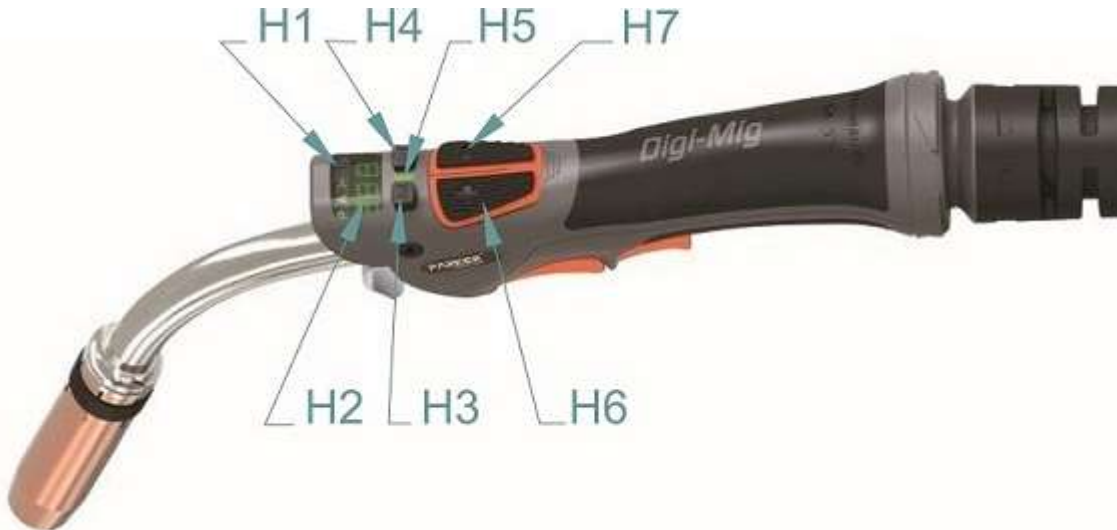

Fig. 9 – Remote control from the torch



Pos.	Description
H1	Display of remote control H1
H2	Display H2
H3	The M button selects functions MAN: Wire feed speed, Voltage/Damping (selectable depending on machine settings - button <b>V13</b> ), JOB SYN: Power, Correction/Damping (selectable depending on machine setting - button <b>V13</b> ), JOB Switch between the different JOBS with the <b>H6 (+)</b> and <b>H7 (-)</b> buttons
H4	Torch button LOCK lock/unlock the buttons UP/DOWN and M The UP/DOWN and M buttons get automatically locked when the torch trigger is pressed.
H5	When the LED is on it indicates UP/DOWN and M button are functioning.
H6	Torch button UP
H7	Torch button DOWN

## ENABLE JOB SWITCHING VIA REMOTE CONTROL (ONLY FOR VERSIONS BELOW 0.14)

1. By long-pressing buttons **V13** and **V20**, at the same time, activate the JOB choice by the remote control.  
Display shows **JOB on**.

2. By means of the button **H3** set the function JOB change.
3. By means of buttons **H6** (UP) and **H7** (DOWN) switch among the saved JOBS.
4. By short-pressing buttons **V13** and **V20**, at the same time, deactivate the JOB choice the by remote control.

Display shows **JOB off**.

Symbols on the torch display <b>H1</b>	
Symbol	Description
<b>P</b>	A synergic program is running on the welding machine
<b>A</b>	Amperage setting (SYN)
	Wire speed setting
No symbol	Material thickness setting (SYN) Voltage setting (MAN)
	Correction (SYN)
Symbols on the torch display <b>H2</b>	
<b>J.xx</b>	JOBS (xx – JOB No)
<b>I.xx</b>	Choke level (SYN/MAN). (Only with firmware 2015 and newer)
<b>ELE</b>	Machine is in MMA (Electrode) mode

## RESET

1. Pressing **V8** and **V20** at the same time more than 3 s makes RESET – default parameters will be restored.
2. It will delete saved JOBS!

## 8. MIG/MAG WELDING SYNERGY

1. Choose SYN method (see SETTING THE METHOD OF WELDING).
2. Left display **V10** shows machine output (current, wire feed speed, material thickness), right display **V11** shows voltage value.

Correction value (voltage, wire feed speed) or choke value is shown on the display **V11** only during the start process.

3. Press the button **V8** to switch setting and view of machine output (current, wire feed speed, material thickness).

4. Machine output (current, wire feed speed, material thickness) set by the encoder **V5**.
5. In the calibration menu you can set the choice of turning off correction zeroing at the change of the machine output value.
6. By long-pressing the button **V13** switch between voltage correction and wire feed speed. By short-pressing this button switch between set correction and choke value.
7. Set the voltage correction, wire feed speed or choke value by the encoder **V16** (if necessary).
8. Press the button **V20** to switch between modes **2T/4T/2T stairs/4T stairs**.
9. In the mode **2T stairs/4T stairs** you cannot set the parameters during the welding process.
10. If is connected the torch with remote control, on its display is shown machine output (current, fire feed speed, material thickness), correction (voltage, wire feed speed) or choke value. With buttons **H6** (UP) and **H7** (DOWN) set the displayed value, with the button **MODE** switch between functions. If is activated the JOB choice by the remote control, you can switch between JOBs.

## 9. PULSED MODE

(does not apply to aXe 250 MOBIL GAS and aXe 320 MOBIL GAS)

1. With the button **V2** switch on the pulsed mode (only at stated synergic programs).
2. If is the pulsed mode switched on, LED **V3** at the button **V2** shines.
3. Left display **V10** shows machine output (current, wire feed speed, material thickness), right display **V11** shows voltage value. Correction value (voltage, wire feed speed) is displayed on the display **V11** only when you setting.
4. By pressing the button **V8** can change the machine output screening (current, wire feed speed, material thickness).
5. Set the machine output (current, wire feed speed, material thickness) by the encoder **V5**.
6. In the calibration menu you can set the choice of turning off correction zeroing at the change of the machine output value.
7. By long-pressing the button **V13** switch voltage correction and wire feed speed.
8. Set the voltage correction or wire feed speed by the encoder **V16** (if necessary).
9. Press the button **V20** to switch between modes **2T/4T/2T stairs/4T stairs**.

10. If is connected the torch with remote control, on its display is shown machine output (current, fire feed speed, material thickness), correction (voltage, wire feed speed). With buttons **H6** (UP) and **H7** (DOWN) set the displayed value, with the button **MODE** switch between functions. If is activated the JOB choice by the remote control, you can switch between JOBS.

## 10. MIG/MAG WELDING MANUAL

1. Choose MAN method (see SETTING THE METHOD OF WELDING).
2. Left display **V10** shows MAN.
3. Left display **V10** shows wire feed speed, right display **V11** shows voltage or choke.
4. Wire feed speed set by the encoder **V5**.
5. Voltage or choke set by the encoder **V16**.
6. By long-pressing the button **V13** switch settings and screening of voltage or choke.
7. Press the button **V20** to switch between modes **2T/4T**.
8. During welding, the left display **V10** shows measured values of welding current and the right display **V11** shows voltage.
9. After welding, on the displays will remain measured values (**HOLD**) for 6 s.
10. If is connected the torch with remote control, on its display is shown wire feed speed, voltage or choke. With buttons **H6** (UP) and **H7** (DOWN) set the displayed value, with the button **MODE** switch between functions. If is activated the JOB choice by the remote control, you can switch between JOBS.

### WELDING VOLTAGE

It is set using voltage encoder **V16**.

### WELDING CURRENT – GENERAL INFORMATION

Size of the welding current depends on the wire feed speed and voltage. Characteristic of the curve ("hardness / softness") can be controlled by correction of the choke.

Approximate setting for the MIG / MAG welding current and voltage corresponds the empirical relationship  $U_2 = 14 + 0.05 I_2$ . According to this relationship, we can determine the required voltage. When setting the voltage, we expect the decline in voltage during load. The voltage drop is approximately 4.5-5.0 V at 100 A.

Set the welding current by setting the welding voltage first and then configure the wire feed speed to the point, where the burning of the arc is ideal.



Please note that the actual settings for ideal arc may vary slightly depending on the position of the weld material and voltage fluctuations.

To achieve a good quality of the welds and the optimum setting of the welding current it is necessary to ensure that the distance of the power nozzle from the material was about 10 times the diameter of the welding wire (pic. 10).

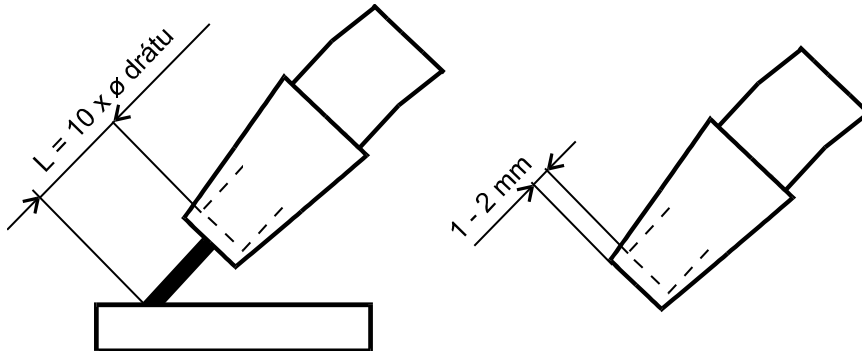

Fig. 10 – Distance from nozzle to material

### TABLE OF WIRE CONSUMPTION DURING WELDING

Wire diameter [mm]	Range of wire feed speed [m/min]	Maximal wire feed speed [m/min]	Weight of 1 m wire [g]	Wire consumption per 1 minute of welding [g/min]	Wire consumption per 1 hour of welding [g/hour]
<b>Steel wire</b>					
0,6	2 - 5	5	2,3	11,5	690
0,8	3 - 6	6	4	24	1440
1,0	3 - 12	12	6	72	4320
1,2	4 -18	18	9	162	9720
<b>Stainless steel wire</b>					
0,6	2 - 5	5	2,3	11,5	690
0,8	3 - 6	6	4	24	1440
1,0	3 - 12	12	6	72	4320
1,2	4 -18	18	9	162	9720
<b>Aluminum wire</b>					
0,6	2 - 5	5	0,8	4	240
0,8	3 - 6	6	1,3	7,8	468
1,0	3 - 12	12	2	24	1440
1,2	4 -18	18	3	54	3240

### TABLE OF GAS CONSUMPTION DURING WELDING

Wire diameter [mm]	Gas flow [l/min]	Gas consumption per 1 hour of welding [l/hour]
0,6	6	6 * 60 = 360
0,8	8	8 * 60 = 480
1,0	10	10 * 60 = 600
1,2	12	12 * 60 = 720

1,6	16	16 * 60 = 960
2,0	20	20 * 60 = 1200

## 11. MMA WELDING (COATED ELECTRODE- ELE)

1. Choose MMA method (see SETTING THE METHOD OF WELDING).
2. Left display **V10** shows the value of welding current, right display **V11** shows ELE.
3. Welding current set by the encoder **V5**.
4. During welding, the left display **V10** shows measured value of welding current and the right display **V11** shows voltage.
5. After welding, on the display will remain measured value (**HOLD**) for 6 s.
6. If is connected the torch with remote control, on its display is shown ELE.
7. **If stays connected the MIG/MAG torch, on the torch will be the welding voltage.**

### TABLE OF ELECTRODE CONSUMPTION DURING WELDING

Electrode diameter [mm]	Range of welding current [A]	Total electrode length [mm]	Weight of boiled electrode without slag [g]	Boiled electrode time [s]	Weight of boiled electrode without slag per 1 second [g/s]
1,6	30 - 55	300	4	35	0,11
2,5	70 - 110	350	11	49	0,22
3,2	90 - 140	350	19	60	0,32
4,0	120 - 190	450	39	88	0,44

## 12. ROUTINE MAINTENANCE & INSPECTION

1. The only routine maintenance required for the aXe range of machines is a thorough cleaning and inspection, with the frequency depending on the usage and the operating environment.

 WARNING 

2. Disconnect the aXe from the mains supply voltage before disassembling.
3. Special maintenance is not necessary for the control unit parts in the Welder. If these parts are damaged for any reason, replacement is recommended.

 CAUTION 

4. Do not blow air into the welder during cleaning. Blowing air into the welder can cause metal particles to interfere with sensitive electronic components and cause damage to the welder.
5. To clean the welder, disconnect it from the mains supply voltage then open

the enclosure and use a vacuum cleaner to remove any accumulated dirt and dust. The welder should also be wiped clean. If necessary, solvents that are recommended for cleaning electrical apparatus may be used.

6. Troubleshooting and repairing of the aXe welding equipment should only be carried out only by suitably qualified or competent person.
7. A 'competent person' must be a person who has acquired through training, qualification or experience, or a combination of them, the knowledge and skills enabling that person to safely carry out a risk assessment and repairs to the electrical equipment in question.
8. The person carrying out the servicing needs and repairs must know what to look at, what to look for and what to do.

## OPERATIONAL SAFETY INSPECTION OF THE MACHINE ACCORDING TO ČSN EN 60 974-4

Prescribed operations of tests, procedures, and required documentation are listed in ČSN EN 60974-4. SERVIS

### ERROR MESSAGES

The left display **V10** shows Err, the right display **V11** shows number / marking of the error.

Err 1	Overheating of the machine. DO NOT POWER OFF THE MACHINE!
Err noP	Pulsed mode cannot turn on for the selected synergic program.
Err noS	Pulsed mode cannot turn off, synergic program in only for the pulsed mode.

### TROUBLE SHOOTING

Symptom	Reason	Solution
The torch is too hot.	Nozzle is not fixed.	Tighten the nozzle.
Button on the torch does not respond.	Connectivity of EURO connector is loose.	Tighten EURO connector.
	Damaged wiring in the torch.	Check and replace if necessary.
Irregular wire feed or wire is caked to the nozzle.	The wire on the spool is too tightly wound.	Check and replace the spool if necessary.
	The ball is fused to the nozzle.	Cut out the ball and piece of the wire at the beginning.
Irregular or no wire feed.	Poor pressure in the wire feed rolls.	Adjust the pressure according to this instruction manual.
	The torch is damaged.	Check and replace if necessary.

	The groove on the feed roll does not correspond to the welding wire diameter.	Put the correct roll.
	Bad quality of the wire.	Check and replace if necessary.
	The liner in the torch is unclean or damaged.	Check and replace if necessary.
	Spool brake is badly configured.	Adjust it according to this instruction manual.
Arc or short circuit between the hose and the nozzle.	Glued spatter inside the gas nozzle.	Remove the spatter.
Unstable arc.	Incorrect diameter of the nozzle or too worn out or damaged nozzle.	Change the nozzle.
Inadequate supply of a protective gas, pores in the weld.	Poorly set the amount of supplied gas.	Set the correct amount as described in this instruction manual.
	Reducing valve on the bottle is dirty.	Check and replace if necessary.
	The torch or gas hoses are dirty.	Check and replace if necessary.
	Protective gas is blown away by draft.	Stop the draft.
Bad welding power.	Missing phase.	Try to connect the machine to a different outlet. Check the power supply cable and circuit breaker.
	Poor grounding.	Ensure the best connection between the work piece and the earthing cable / clamps of the machine.
	The grounding cable is poorly attached to the connector on the machine.	Tighten the earthing cable in the connector on the machine.
	Torch damaged.	Check and replace if necessary.

During feeding welding wire is rubbed.	The groove on the feed roll does not correspond to the welding wire diameter.	Put the correct roll.
	Wrong pressure in the upper wire feed roll.	Adjust the pressure according to this instruction manual.

### 13. STATEMENT OF WARRANTY

1. In accordance with the warranty periods stated below, ALFA IN guarantees the proposed product to be free from defects in material or workmanship when operated in accordance with the written instructions as defined in this operating manual.
2. ALFA IN welding products are manufactured for use by commercial and industrial users and trained personnel with experience in the use and maintenance of electrical welding and cutting equipment.
3. ALFA IN will repair or replace, at its discretion, any warranted parts or components that fail due to defects in material or workmanship within the warranty period. The warranty period begins on the date of sale to the end user.
4. If warranty is being sought, please contact your ALFA IN product supplier for the warranty repair procedure.
5. ALFA IN warranty will not apply to:
  - a. Equipment that has been modified by any other party other than ALFA IN's own service personnel or with prior written consent obtained from ALFA IN Service Department.
  - b. Equipment that has been used beyond the specifications established in the operating manual.
  - c. Installation not in accordance with the installation/operating manual.
  - d. Any product that has been subjected to abuse, misuse, negligence or accident.
  - e. Failure to clean and maintain (including lack of lubrication, maintenance and protection), the machine as set forth in the operating, installation or service manual.
6. Within this operating manual are details regarding the maintenance necessary to ensure trouble free operation.



Warranty repairs must be performed by either an ALFA IN Service Centre, an ALFA IN distributor or an Authorized Service Agent approved by the company ALFA IN.

7. As a warranty list serves proof of purchase (invoice) on which is the serial number of the machine, eventually a warranty list on the last page of this manual.

## 14. DISPOSAL



Only for EU countries. Do not dispose of electric tools together with household waste material.

■ In accordance with European Council Directive 2002/96/EC on electrical and electronic equipment waste and its implementation in accordance with national law, electric tools that have reached the end of their service life must be collected separately and returned to an environmentally compatible recycling facility.

## 15. WARRANTY LIST

As a warranty list serves proof of purchase (invoice) on which is the serial number of the machine, eventually a warranty list below, which is filled in by an authorized dealer.

Serial number:	
Day, month (written in words) and year of sale:	
Stamp and dealer signature:	