



WELDING INVERTER

PAN 160

OPERATING MANUAL

CONTENT:

1	INTRODUCTION	1
2	 SAFETY INSTRUCTIONS AND WARNINGS 	2
3	ELECTROMAGNETIC COMPATIBILITY (EMC)	4
4	TECHNICAL DATA	4
5	EQUIPMENT	5
5.1	ACCESSORIES TO ORDER	5
6	OPERATOR CONTROLS	5
6.1	FRONT PANEL	6
7	GETTING STARTED	6
7.1	GETTING STARTED MMA – COATED ELECTRODE	6
7.2	GETTING STARTED TIG LIFT ARC	6
7.2.1	How to connect the gas cylinder.....	6
7.2.2	Basic settings for TIG welding – stainless steel, DC current	7
8	ROUTINE MAINTENANCE & INSPECTION	7
9	STATEMENT OF WARRANTY	8
10	DISPOSAL	9

1 INTRODUCTION

Congratulations on your new ALFA IN product. We are proud to have you as our customer and will strive to provide you with the best service and reliability in the industry.

This Operating Manual has been designed to instruct you on the correct use and operation of your ALFA IN product. Your satisfaction with this product and its safe operation is our ultimate concern. Therefore please take the time to read the entire manual, especially the Safety Precautions. They will help you to avoid potential hazards that may exist when working with this product.

Read and understand this entire Manual and your employer's safety practices before installing, operating, or servicing the equipment. While the information contained in this Manual represents the Manufacturer's best judgement, the Manufacturer assumes no liability for its use.

PAN 160 welds by those methods

- a) E – (MMA) coated electrodes up to 4,0 mm
- b) TIG lift arc.

2 SAFETY INSTRUCTIONS AND WARNINGS

- Once the packing has been opened, make sure that the machine is not damaged. If in any doubt, call the service centre.
- This equipment must only be used by qualified personnel.
- During installation, any electric work must only be carried out by trained personnel.
- The machine must be used in a dry place with good ventilation.
- Make sure that no metal dust can be drawn in by the fan inside the machine, as this could cause damage to the electronic circuits.
- It is prohibited to connect more than one INVERTER generator in series or in parallel.
- When installing the machine, follow the local regulations on safety.
- The position of the machine must allow easy access by the operator to the controls and connectors.
- When the welding machine is operating, all its covers and doors must be closed and well fixed.
- Do not expose the welding machine to direct sunlight or to heavy rain. This equipment conforms to protection rating IP23S.
- During welding, the welding cables must be located near or at ground level. They should be as short as possible.
- The operator must wear gloves, clothes, shoes, and a helmet or a welder's helmet, which protect and are fire-resistant in order to protect him against electric shock, flashes and sparks from welding.
- The operator must protect his eyes with safety visor or mask designed for welding, fitted with standard safety filters. He should also be aware that during electrical welding ULTRAVIOLET RADIATION is emitted. Therefore it is vital that his face is also protected from radiation. Ultraviolet rays produce the same harmful effect as sun burning on unprotected skin.
- The operator is obliged to warn anyone near the welding area of the risks that welding involves and to arrange to provide adequate protection equipment.
- It is very important to arrange for sufficient ventilation, especially when welding in enclosed spaces. We suggest using suitable fume extractors to

prevent the risk of intoxication by fumes or gas generated by the welding process.

- The operator must ensure all flammable materials are removed from the work area to avoid any risk of fire.
- The operator must NEVER weld containers that have previously contained petrol, lubricants, gas or similar flammable materials, even if the container has been empty for a considerable time. THERE IS A VERY HIGH RISK OF EXPLOSION.
- The operator must be aware of all the special regulations which he needs to conform to when welding in enclosed spaces with a high risk of explosion.
- To prevent electric shock, we strongly suggest the following rules:
- Do not work in a damp or humid environment.
- Do not use the welding machine if its cables are damaged in any way.
- Make sure that the earthing system of the electric equipment is correctly connected and operational.
- The operator must be insulated from the metal components connected to the return wire.
- The earthing of the piece being worked could increase the risk of injury to the operator.
- EN 60974-1 Standard: Open-circuit voltage. During the operation of the machine, the highest voltage, with which it is possible to come into contact, is the open-circuit voltage between the welding clamps. In our generator this voltage is 63,4V.
- The maximum open-circuit voltage of the welding machines is established by national and international standards (EN 60974-1) depending on the type of weld current to be used, on its waveform and on the hazards arising from the work place. These values are not applicable to the strike currents and those for stabilisation of the arc that could be above it.
- The open-circuit voltage, for as many adjustments as possible, must never exceed the values relating to the various cases shown in the following table:

Case	Working conditions	Open-circuit voltage	
1	Places with increased risk of electric shock	DC current: 113V peak value	AC current: 68V peak value and 48V effective
2	Places without increased risk of electric shock	DC current: 113V peak value	AC current: 113V peak value and 80V effective
3	Torches held mechanically with increased protection for the operator	DC current: 141V peak value	AC current: 141V peak value and 100V effective

- In case 1, the dc welding machines with rectifier must be built in such a

way that, in case of a fault developing in the rectifier (for example open circuit, short circuit or lack of power), the permitted values cannot be exceeded. The welding machines of this type can be marked with the

symbol: **S**

- Before opening the machine switch off the machine and disconnect it from the power socket.
- Only personnel authorised by this company can carry out maintenance on the machine.

3 ELECTROMAGNETIC COMPATIBILITY (EMC)

This welding machine conforms to EN 60974-10 standard. However, the electromagnetic emissions generated could prove not be compatible with the maximum permitted levels for some classes of electrical equipment, such as the following:

- Domestic electronic appliances (radios, TVs, videos, telephones, burglar alarms, etc.).
- Computers, robots, electro-medical instruments and life-support systems.
- Radio-television transmitters and receivers.
- Pacemakers and hearing aids.
- All very sensitive electrical equipment.
- The operator is responsible for the installation and use of the welding machine. If there should be any fault in operations of other systems located in the immediate vicinity of the generator, we recommend suspending operations and consulting the manufacturers.

4 TECHNICAL DATA

	Jednotky	MMA	TIG
Mains voltage	V/Hz	1x230/50-60	
Mains protection	A	16 SLOW	
Max. input power I_1	A	33,1	22,0
Max. effective current $I_{1\text{eff}}$	A	15,7	14,9
Welding current range	A/V	10/20,4 - 160/26,4	10/10,4 - 160/16,4
Open-circuit voltage U_{20}	V	63,4	63,4
Welding current (DC=100%) I_2 / U_2	A/V	80/23,2	120/14,8
Welding current (DC=60%) I_2/U_2	A/V	100/24,0	140/15,6
Welding current (DC=x%) I_2/U_2	A/V	25%=160/26,4	25%=160/16,4
Insulation class		F	
Protection		IP23S	
Standards		EN 60974-1	
Dimensions (w x l x h)	mm	124 x 340 x 205	

Weight	kg	5
--------	----	---

ALFA IN continuously strives to produce the best product possible and therefore reserves the right to change, improve or revise the specifications or design of this or any product without prior notice. Such updates or changes do not entitle the buyer of equipment previously sold or shipped to the corresponding changes, updates, improvements or replacement of such items.

5 EQUIPMENT

5.1 ACCESSORIES TO ORDER

Item No.	Description
V9030034	Welding Cable Set 2x 3m 10-25 150A
5.0110	Box blue
4341	Valve Red.AR MIDI-C M14G W21,8 x 1,14
S777a	Light Reactive Welding Helmet ALFA IN S777a GRAY
706.1057	Torch SRT17 V 4m BSB10-25

6 OPERATOR CONTROLS

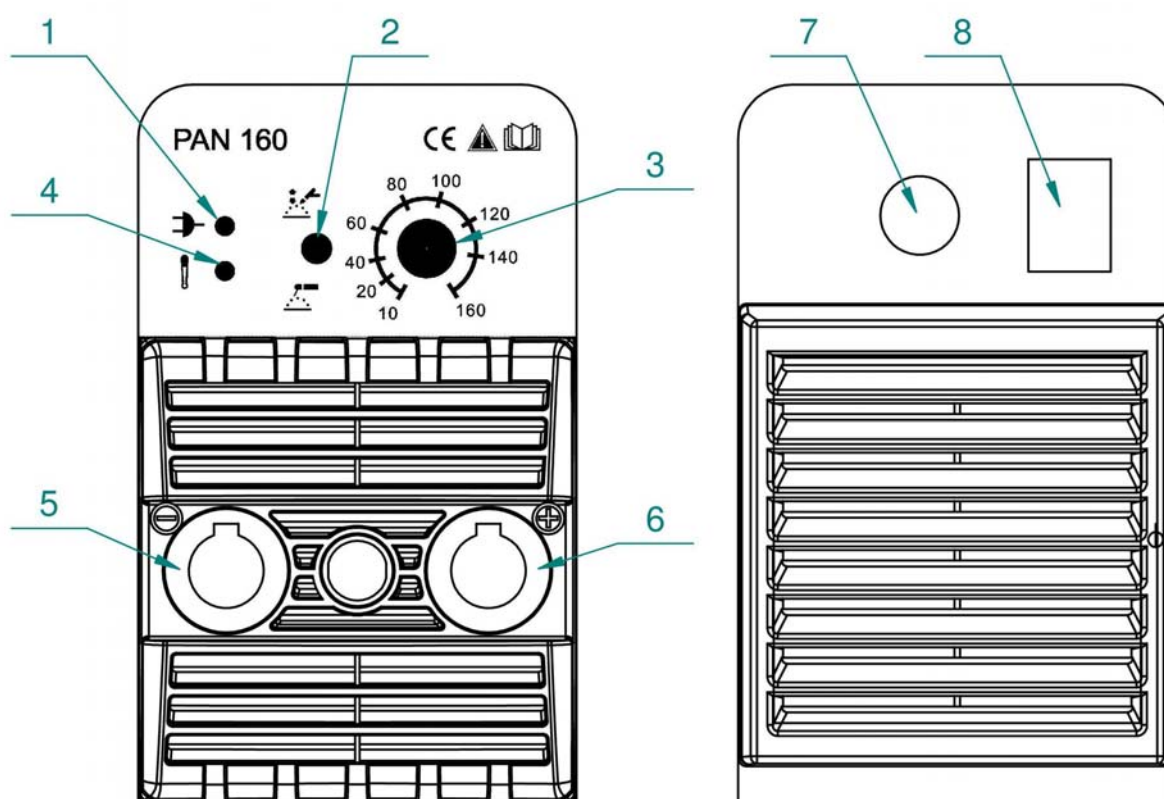

Fig . 1 Main parts

6.1 FRONT PANEL



Pos.	Description
1	LED ON
2	Method switch MMA (electrode)/TIG
3	Current potentiometer
4	LED over heating
5	Panel quick connector -
6	Panel quick connector +
7	Mains cable with a plug
8	ON/OFF switch

7 GETTING STARTED

Insert the mains plug into a suitable 1x230 V (or 1 x 110 V) mains socket. The supply fuses or circuit breaker should correspond to the technical data in section 3. Switch the machine on by the ON/OFF switch 7. LED 1 will illuminate.

7.1 GETTING STARTED MMA – COATED ELECTRODE

- Connect the electrode holder and the work lead to terminals **5** and **6**

according the instructions on the electrode package.  **NOTE** 

Prevent touching the electrode any metal material for in this mode the terminals 5 and 6 are under current.

- By means of the switch **2** select MMA .
- To select the current use potentiometer **3**
- Insert the coated electrode into the electrode holder.

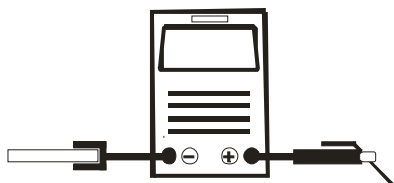

7.2 GETTING STARTED TIG LIFT ARC

- Fit the TIG Torch to the minus terminal **5** and fasten it by turning the connector to the right.
- Connect the work lead to positive terminal **6** and fasten it by turning the connector to the right.
- Connect the work clamp to the work piece or at the welding table.
- By means of the switch **2** select TIG .

7.2.1 How to connect the gas cylinder

- Ensure that the gas cylinder is secured to a building pillar, wall bracket or

otherwise securely fixed in an upright position.

- Open the gas valve once to blow out possible dirt particles.
- Connect the gas regulator to the gas cylinder valve.
- Connect the gas hose of the TIG torch to the gas regulator.
- Open the gas cylinder valve, open the valve on the TIG torch and adjust the gas flow on the gas regulator. The flow rate will be shown at the flow meter. This should be done according the table below.

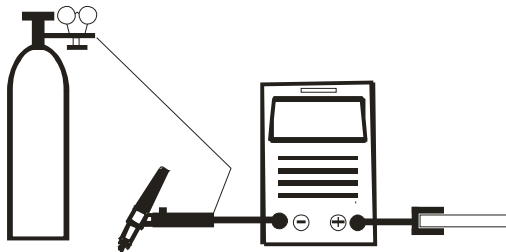

7.2.2 Basic settings for TIG welding – stainless steel, DC current

Material thickness mm	Tungsten electrode diameter mm	Filler material diameter mm	Welding current A	Argon flow l/min	Gas nozzle mm
1	1	1,5	40-60	3	10
1,5	1,5	1,5	50-90	4	10
2	2	2	80-100	4	12
3	2-3	2-3	90-140	5	12
4-5	3-4	3-4	110-180	5	12

8 ROUTINE MAINTENANCE & INSPECTION

- The only routine maintenance required for the PAN range of machines is a thorough cleaning and inspection, with the frequency depending on the usage and the operating environment.



- Disconnect the PAN 160 from the mains supply voltage before disassembling.
- Special maintenance is not necessary for the control unit parts in the Welder. If these parts are damaged for any reason, replacement is recommended.



- Do not blow air into the welder during cleaning. Blowing air into the welder can cause metal particles to interfere with sensitive electronic components and cause damage to the welder.
- To clean the welder, disconnect it from the mains supply voltage then open

the enclosure and use a vacuum cleaner to remove any accumulated dirt and dust. The welder should also be wiped clean. If necessary, solvents that are recommended for cleaning electrical apparatus may be used.

- Troubleshooting and repairing of PAN 160 welding equipment should only be carried out only by suitably qualified or competent person.
- A 'competent person' must be a person who has acquired through training, qualification or experience, or a combination of them, the knowledge and skills enabling that person to safely carry out a risk assessment and repairs to the electrical equipment in question.
- The person carrying out the servicing needs and repairs must know what to look at, what to look for and what to do.

9 STATEMENT OF WARRANTY

- In accordance with the warranty periods stated below, ALFA IN guarantees the proposed product to be free from defects in material or workmanship when operated in accordance with the written instructions as defined in this operating manual.
- ALFA IN welding products are manufactured for use by commercial and industrial users and trained personnel with experience in the use and maintenance of electrical welding and cutting equipment.
- ALFA IN will repair or replace, at its discretion, any warranted parts or components that fail due to defects in material or workmanship within the warranty period. The warranty period begins on the date of sale to the end user.
- If warranty is being sought, please contact your ALFA IN product supplier for the warranty repair procedure.
- ALFA IN warranty will not apply to:
 - Equipment that has been modified by any other party other than ALFA IN's own service personnel or with prior written consent obtained from ALFA IN Service Department.
 - Equipment that has been used beyond the specifications established in the operating manual.
 - Installation not in accordance with the installation/operating manual.
 - Any product that has been subjected to abuse, misuse, negligence or accident.
 - Failure to clean and maintain (including lack of lubrication, maintenance and protection), the machine as set forth in the operating, installation or service manual.
- Within this operating manual are details regarding the maintenance necessary to ensure trouble free operation.



- Warranty repairs must be performed by either an ALFA IN Service Centre,

an ALFA IN distributor or an Authorised Service Agent approved by the company ALFA IN.

10 DISPOSAL



Only for EU countries. Do not dispose of electric tools together with household waste material.

■ In accordance with European Council Directive 2002/96/EC on electrical and electronic equipment waste and its implementation in accordance with national law, electric tools that have reached the end of their service life must be collected separately and returned to an environmentally compatible recycling facility.