

WELDING INVERTER

PEGAS 200 AC/DC PULSE

OPERATING MANUAL

CONTENT:

1. INTRODUCTION.....	3
2. SAFETY INSTRUCTIONS AND WARNINGS	4
3. TECHNICAL DATA	6
4. EQUIPMENT	7
5. OPERATOR CONTROLS	8
6. GETTING STARTED	10
7. TWO STROKE AND FOUR STROKE IN TIG MODE	13
8. ROUTINE MAINTENANCE & INSPECTION	14
9. STATEMENT OF WARRANTY.....	15
10. DISPOSAL	15
11. WARRANTY LIST	16

1. INTRODUCTION

Congratulations on your new ALFA IN product. We are proud to have you as our customer and will strive to provide you with the best service and reliability in the industry.

This Operating Manual has been designed to instruct you on the correct use and operation of your ALFA IN product. Your satisfaction with this product and its safe operation is our ultimate concern. Therefore please take the time to read the entire manual, especially the Safety Precautions. They will help you to avoid potential hazards that may exist when working with this product.

Read and understand this entire Manual and your employer's safety practices before installing, operating, or servicing the equipment. While the information contained in this Manual represents the Manufacturer's best judgement, the Manufacturer assumes no liability for its use.

PEGAS 200 AC/DC PULSE welds by those methods

1. E – (MMA) DC coated electrodes up to 4,0 mm
2. E – (MMA) AC coated electrodes up to 4,0 mm
3. TIG DC (Lift arc or High Frequency ignition)
4. TIG AC (Lift arc or High Frequency ignition)

We reserve the law of adjustments and changes in case of printing errors, change of technical paramaters, accessories etc. without previous notice. These changes may not be reflected in the manuals for use in paper or electronic form.

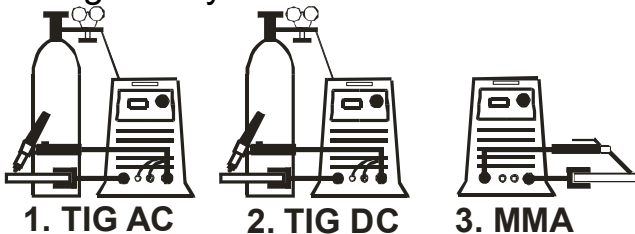

2. SAFETY INSTRUCTIONS AND WARNINGS

Once the packing has been opened, make sure that the machine is not damaged. If in any doubt, call the service centre.

This equipment must only be used by qualified personnel.

During installation, any electric work must only be carried out by trained personnel.

The machine must be used in a dry place with good ventilation.

Make sure that no metal dust can be drawn in by the fan inside the machine, as this could cause damage to the electronic circuits.

It is prohibited to connect more than one INVERTER generator in series or in parallel.

When installing the machine, follow the local regulations on safety.

The position of the machine must allow easy access by the operator to the controls and connectors.

When the welding machine is operating, all its covers and doors must be closed and well fixed.

Do not expose the welding machine to direct sunlight or to heavy rain. This equipment conforms to protection rating IP23S.

During welding, the welding cables must be located near or at ground level. They should be as short as possible.

The operator must wear gloves, clothes, shoes, and a helmet or a welder's helmet, which protect and are fire-resistant in order to protect him against electric shock, flashes and sparks from welding.

The operator must protect his eyes with safety visor or mask designed for welding, fitted with standard safety filters. He should also be aware that during electrical welding ULTRAVIOLET RADIATION is emitted. Therefore it is vital that his face is also protected from radiation. Ultraviolet rays produce the same harmful effect as sun burning on unprotected skin.

The operator is obliged to warn anyone near the welding area of the risks that welding involves and to arrange to provide adequate protection equipment.

It is very important to arrange for sufficient ventilation, especially when welding in enclosed spaces. We suggest using suitable fume extractors to prevent the risk of intoxication by fumes or gas generated by the welding process.

The operator must ensure all flammable materials are removed from the work area to avoid any risk of fire.

The operator must NEVER weld containers that have previously contained petrol, lubricants, gas or similar flammable materials, even if the container has been empty for a considerable time. THERE IS A VERY HIGH RISK OF EXPLOSION.

The operator must be aware of all the special regulations which he needs to conform to when welding in enclosed spaces with a high risk of explosion.

To prevent electric shock, we strongly suggest the following rules:

Do not work in a damp or humid environment.

Do not use the welding machine if its cables are damaged in any way.

Make sure that the earthing system of the electric equipment is correctly

connected and operational.

The operator must be insulated from the metal components connected to the return wire.

The earthing of the piece being worked could increase the risk of injury to the operator.

EN 60974-1 Standard: Open-circuit voltage. During the operation of the machine, the highest voltage, with which it is possible to come into contact, is the open-circuit voltage between the welding clamps.

The maximum open-circuit voltage of the welding machines is established by national and international standards (EN 60974-1) depending on the type of weld current to be used, on its waveform and on the hazards arising from the work place. These values are not applicable to the strike currents and those for stabilisation of the arc that could be above it.

The open-circuit voltage, for as many adjustments as possible, must never exceed the values relating to the various cases shown in the following table:

Case	Working conditions	Open-circuit voltage	
1	Places with increased risk of electric shock	DC current: 113V peak value	AC current: 68V peak value and 48V effective
2	Places without increased risk of electric shock	DC current: 113V peak value	AC current: 113V peak value and 80V effective
3	Torches held mechanically with increased protection for the operator	DC current: 141V peak value	AC current: 141V peak value and 100V effective

In case 1, the dc welding machines with rectifier must be built in such a way that, in case of a fault developing in the rectifier (for example open circuit, short circuit or lack of power), the permitted values cannot be exceeded.

Before opening the machine switch off the machine and disconnect it from the power socket.

Only personnel authorised by this company can carry out maintenance on the machine.

NOTE:

Device complies with IEC 61000-3-12.

Working ambient temperature between -10 and +40 °C.

Relative humidity below 90% at +20 °C.

Up to 3000 m altitude.

ELECTROMAGNETIC COMPATIBILITY

The welding device is in terms of interference designed primarily for industrial areas. It meets the requirements of EN 60974-10 class A and it isn't designed for using in residential areas, where the electrical energy is supplied by public low-voltage power supply network. It can be here potential problems with ensuring of electromagnetic compatibility in this areas, due to interference

caused by power lines as well as the radiated interference.

During operation, the device may be the source of interference.

 Caution 

We warn users, that they are responsible for possible interference from welding.

3. TECHNICAL DATA

Method		MMA - AC	MMA - DC
Mains voltage	V/Hz	1x230/50-60	
Mains protection	A	16T *)	
Max. input power I_1	A	40,3	
Max. effective current I_{1eff}	A	20,2	
Welding current range	A	10 - 170	5 - 170
Open-circuit voltage U_{20}	V	73	68
Welding current (DC=100%) I_2 $t_a=40\text{ }^\circ\text{C}$	A	70	80
Welding current (DC=60%) I_2 $t_a=40\text{ }^\circ\text{C}$	A	90	110
Welding current (DC=x%) I_2 $t_a=40\text{ }^\circ\text{C}$	A	20%=170	25%=170
Welding current (DC=100%) I_2 $t_a=25\text{ }^\circ\text{C}$	A	90	110
Welding current (DC=60%) I_2 $t_a=25\text{ }^\circ\text{C}$	A	110	130
Welding current (DC=x%) I_2 $t_a=25\text{ }^\circ\text{C}$	A	25%=170	30%=170
Insulation class		F	
Protection		IP23S	
Standards		EN 60 974-1, EN 60 974-10 cl.A	
Dimensions (w x l x h)	mm	250 x 470 x 400	
Weight	kg	21,8	

Method		TIG - AC	TIG - DC
Mains voltage	V/Hz	1x230/50-60	
Welding current range	A	10 - 20	5 - 200
Open-circuit voltage U_{20}	V	73	68
Welding current (DC=100%) I_2 $t_a=40\text{ }^\circ\text{C}$		70	80
Welding current (DC=60%) I_2 $t_a=40\text{ }^\circ\text{C}$	A	90	110
Welding current (DC=x%) I_2 $t_a=40\text{ }^\circ\text{C}$	A	20%=200	25%=200

Welding current (DC=100%) I ₂ t _a =25 °C	A	90	11
Welding current (DC=60%) I ₂ t _a =25 °C	A	110	13
Welding current (DC=x%) I ₂ t _a =25 °C	A	25%=200	30%=200

ALFA IN continuously strives to produce the best product possible and therefore reserves the right to change, improve or revise the specifications or design of this or any product without prior notice. Such updates or changes do not entitle the buyer of equipment previously sold or shipped to the corresponding changes, updates, improvements or replacement of such items.

4. EQUIPMENT

CONTENT OF DELIVERY

Item No.	Description	Quantity
5.0238-2	PEGAS 200 AC/DC PULSE	1
5.0189	Set of Connectors for PEGAS AC/DC	1

ACCESSORIES TO ORDER

Item No.	Description
VM0410	Hose Gas 3m Pegas quick connector G1/4 AERO
VM0253	Welding Cable Set 2x 3m 35-50 200A
5.0216	CS 601 W Cooling Unit PEGAS
5.0508	Welders Cart P 80
26FSL4A	Torch PARKER SGT 26 4m 35-50 FX AERO
26FSL4AUD	Torch PARKER SGT 26 4m 35-50 FX AERO UD
26FSL8A	Torch PARKER SGT 26 8m 35-50 FX AERO
26FSL8AUD	Torch PARKER SGT 26 8m 35-50 FX AERO UD
6008	Pressure Reducer FIXICONTROL Ar 2 manometers GCE
5.0174	Foot Pedal Remote CTRL 3 m PEGAS incl. Connector

5. OPERATOR CONTROLS

MAIN PARTS

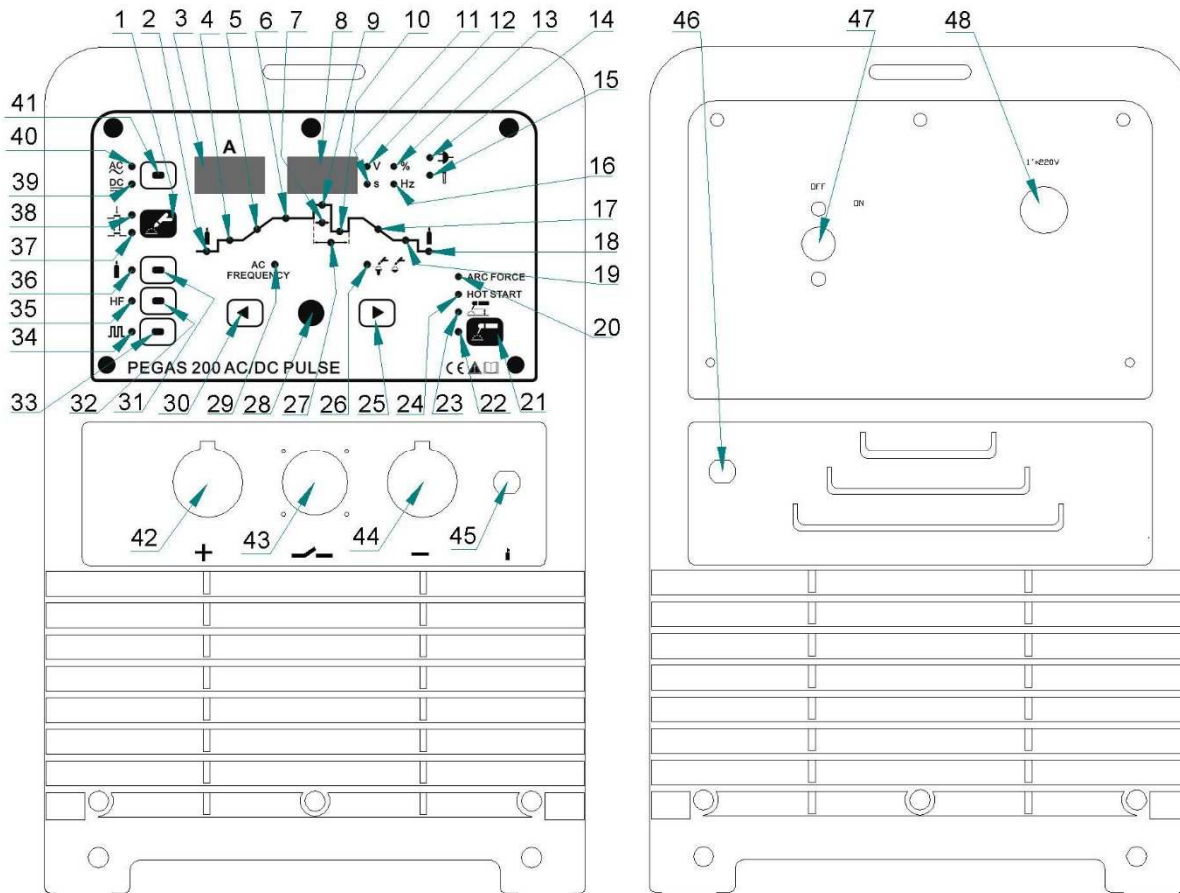

Fig . 1 Main parts

Pos.	Description
1	Button TIG 2T or 4T (two stroke, four stroke)
2	LED Pregas. 0,1 – 1 s, default 0,3 s
3	Current Display
4	LED start current (just 4T). 5 – 100 % of the main welding current. DC, 10 – 100 % AC, Default 5%.
5	LED Up slope. 0 – 10 s, default 0 s.
6	LED Main Welding Current. 5 – 200 TIG DC, 10 – 200 TIG AC, 5 – 170 MMA DC, 10 – 170 MMA AC
7	LED ratio of the pulse current and the base current . 5 – 100 %. Default 5 %.Just for the pulse mode.
8	Display Voltage, %, time and Hz.
9	LED Main Welding Current in the pulse mode. 5 – 200 A DC, 10 – 200 TIG AC

10	LED Pulse Base Current. 5 – 200 A DC, 10 -200 A AC.
11	LED Time (s). If illuminated there are values in s on the display 8.
12	LED Voltage (V). If illuminated there are values in V on the display 8.
13	LED %. If illuminated there are values in % on the display 8.
14	LED ON
15	LED ALARM. If illuminated there is under or over voltage in the mains or the machine is overheated and if there are faulty output diodes and transistors on main board. At the same time the displays show Err 001.
16	LED Hz. If illuminated there are values in Hz on the display 8.
17	LED Down Slope, 0 – 10 s, default 0 s.
18	LED Post Gas, 0,1 – 10 s, default 3 s.
19	LED end current, 5 – 100 % of the Main Welding Current DC, 10 – 100 % of the Main Welding Current AC, default 5 %. Just in 4T.
20	LED ARC FORCE for MMA, 0 – 10.
21	MMA switch
22	LED MMA. Can be turned off by means of pressing button 1.
23	LED Arc Length, 0 – 10.
24	LED HOT START, 0 – 10.
25	Button for moving to the right on the parameters curve.
26	LED Balance (just TIG AC). Used for elimination of the aluminium oxides. Range 15 – 50 %, default 15% (more in the text below).
27	LED Pulse Frequency. 0,5 – 200 Hz, default 0,5 Hz. Just in the pulse mode.
28	Encoder
29	LED AC Frequency (just TIG AC). Range: 50-250 Hz. The higher current, the more the maximal frequency decreases. The range of frequency at the maximal current is 50 – 100 Hz.
30	Button for moving to the left on the parameters curve.
31	Gas test.
32	Button switch HF/LIFT ARC.
33	Button switch Pulse/Non pulse mode.
34	LED Pulse. If illuminated the Pulse mode was set.
35	LED HF. If illuminated the HF ignition was set.
36	LED Gas Test. If illuminated the mode of setting the gas flow was

	selected (by means of the gas valve on the gas cylinder). To turn it off press the button 31 again or it will go off this mode after 10 s.
37	LED Four Stroke (4T).
38	LED Two Stroke (2T).
39	LED DC
40	LED AC
41	Button switch AC/DC mode.
42	Quick connector +
43	Torch control connector (pin 8 and 9)
44	Quick connector -
45	Gas connector of the welding torch
46	Gas inlet
47	Mains cable and plug
48	ON/OFF switch

6. GETTING STARTED

Getting started must be consistent with technical data and conditions of use.

GETTING STARTED MMA – COATED ELECTRODE

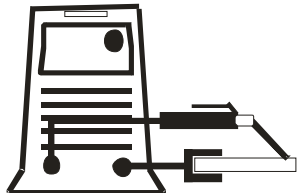

1. Insert the mains plug **41** into a suitable 1x230 V mains socket. The supply fuses or circuit breaker should correspond to the technical data stated in this manual.
2. Connect the welding cables to the panel quick connectors (+) **42** and (-) **44** according the instruction on the electrodes packing.
3. Switch the machine on by the ON/OFF switch **48**.
4. Set the welding current by means of Encoder **28**. The values will be showed on the display **3**.
5. It is possible to change the settings of the HOT START (increase of current during arc ignition time), **ARC FORCE** (an automatic increase of the welding current in case the electrode touches the welding piece) and **Arc Length** by means of the Button **21** and the Encoder **28**.
6. Then switch to the MMA mode by means of the button 21. LEDs **20**, **23** or **24** may not illuminate.
7. **NOTE** Prevent touching the electrode any metal material for in this mode the terminals **42** and **44** are under current.
8. Insert the coated electrode into the electrode holder, connect the clamps of the ground cable to the welding piece and you may start welding.

TABLE OF ELECTRODE CONSUMPTION DURING WELDING

Electrode diameter [mm]	Range of welding current [A]	Total electrode length [mm]	Weight of boiled electrode without slag [g]	Boiled electrode time [s]	Weight of boiled electrode without slag per 1 second [g/s]
1,6	30 - 55	300	4	35	0,11
2,5	70 - 110	350	11	49	0,22
3,2	90 - 140	350	19	60	0,32
4,0	120 - 190	450	39	88	0,44

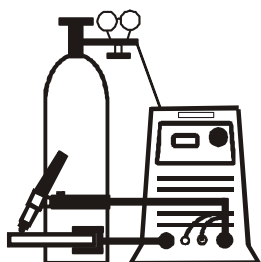
GETTING STARTED TIG

1. Insert the mains plug **41** into a suitable 1x230 V mains socket. The supply fuses or circuit breaker should correspond to the technical data stated in this manual.
2. Fit the TIG Torch to the Panel quick connector (-) **44** and fasten it by turning the connector to the right.
3. Connect the gas hose of the TIG torch onto Gas outlet connector **45**.
4. Connect the torch control connector onto the matching connector **43**.
5. Connect the work lead to Panel quick connector (+) **42** and fasten it by turning the connector to the right.
6. Connect the gas hose to the reduction valve on the gas cylinder and on the Gas inlet connector **46** on the rear panel.
7. Switch the machine on by the ON/OFF switch **48**.
8. Select the Gas setting mode by means of pressing the button **31**, LED **36** will illuminate. Set the flow of the argon gas by means of the pressure reduction valve on the gas cylinder.
9. Select 2T (two stroke) or 4T (four stroke) mode by means of switch **1**. The corresponding LED will light up.
10. Select the method desired TIG DC or AC method by means of the button **41**. The corresponding LED will light up.
11. In the welding torch must be installed a corresponding tungsten electrode (for AC green or golden). The electrode should be sharpened also corresponding to the AC or DC mode.
12. Select HF or list arc ignition by means or switch **4**.
13. Set the welding current by means of Encoder **28**. The values will be showed on the display **3**.
14. Other parameters may be set by means of buttons **30** and **25** and the encoder **28**. The corresponding LEDs will light up. The set parameter will be automatically memorised when you move to another parameter of after 3 s. More in the table MAIN PARTS above.
15. Connect the work clamp to the work piece or at the welding table and you can start welding.
16. The following table describes the influence setting the clearance

effect.

Clearance effect	Value 20-30%	Value 50%
Shape of the current curve		
Penetration	Shallow	Deep
Level of wear of the tungsten electrode	Smaller	Bigger

TABLE OF CONSUMPTION DURING TIG WELDING

Wolfram electrode diameter [mm]	Argon flow [l/min]
	Steel / stainless steel
0,5	3 – 4
1,0	3 – 5
1,6	4 – 6
2,4	5 – 7
3,2	5 – 9

REMOTE CONTROL

The PEGAS 200 AC/DC PULSE supports three kinds of remote controls.

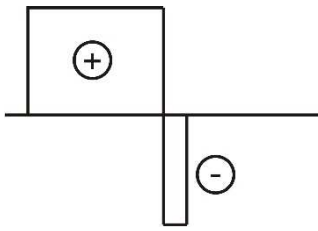
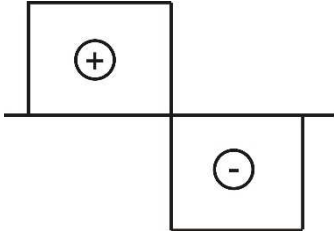
1. TIG torch with UP-DOWN buttons
2. Foot pedal
3. Standard separate remote control for changing the value of the welding current.

All three models of remote controls can be connected by means of the front panel connector **43**.

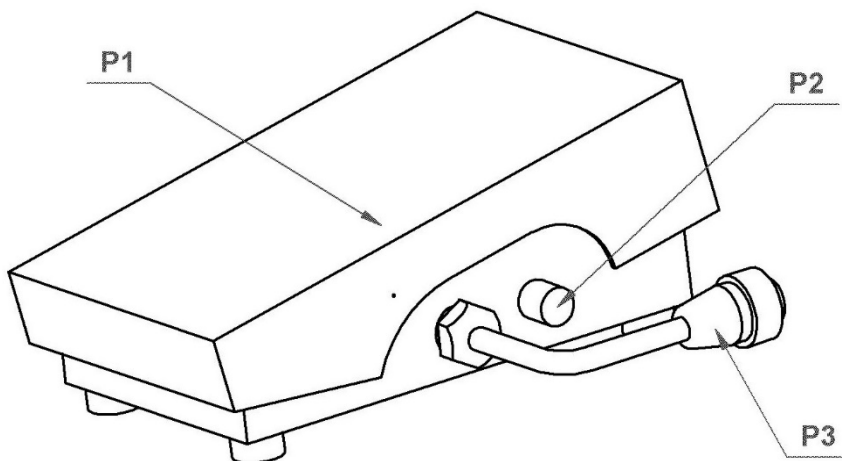

Fig . 2 Foot pedal remote control

Pos.	Description
P1	Stepping surface
P2	Potentiometer of setting the limit of maximal welding current
P3	Connector (connect to matching connector 13 on the front panel)

1. When you connect the **P3** connector to matching connector on the front panel **43** the function setting the current from the front panel will be blocked, instead of that the max. current is limited by the potentiometer **P2**.
2. By pressing the stepping surface down you start the welding process. The value of the welding current depends on the level of pressing the stepping surface. To reach the maximal current limited by potentiometer **P2** requires to gently pressing to the lowest position of the stepping surface **P1**. The set current will be displayed on the current display **3**.
3. The welding process ends after releasing the stepping surface **P1**.

7. TWO STROKE AND FOUR STROKE IN TIG MODE

TWO STROKE – 2T

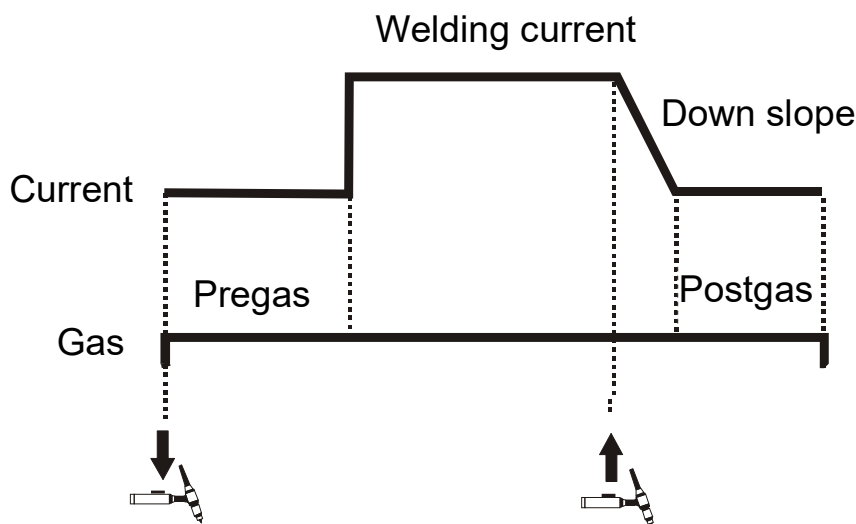

FOUR STROKE – 4T

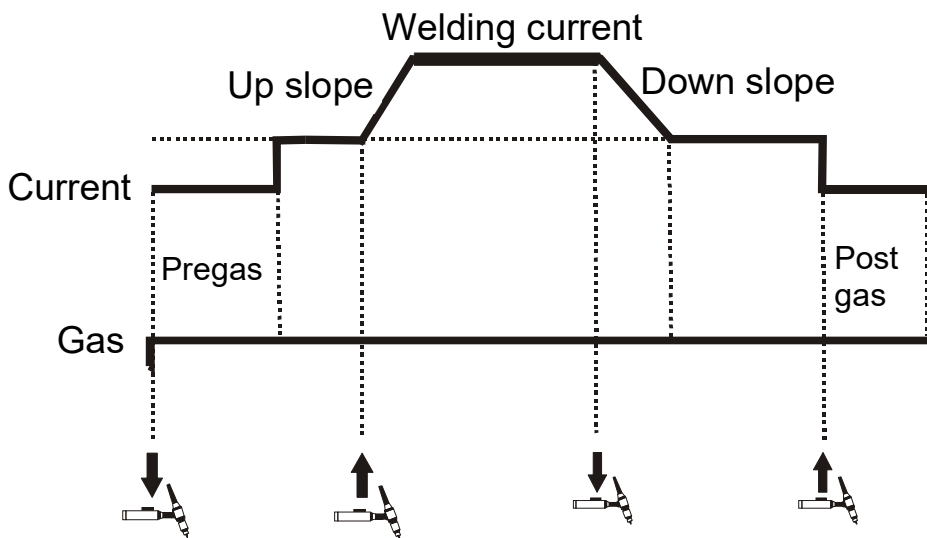

BILEVEL – SECOND WELDING CURRENT

When the machine is in 4T mode, there is always active the BILEVEL function. The value of the second current is automatically set to 50% of the pre-set value of the main welding current. To enter the second welding current press the torch button for a short time and release it. To get back to the main welding current press the torch button for a short time and release it.

8. ROUTINE MAINTENANCE & INSPECTION

The only routine maintenance required for the PEGAS range of machines is a thorough cleaning and inspection, with the frequency depending on the usage and the operating environment.

👉 **WARNING** 👉 Disconnect the PEGAS from the mains supply voltage before disassembling.

Special maintenance is not necessary for the control unit parts in the Welder. If these parts are damaged for any reason, replacement is recommended.

👉 **CAUTION** 👉 Do not blow air into the welder during cleaning. Blowing air into the welder can cause metal particles to interfere with sensitive electronic components and cause damage to the welder.

To clean the welder, disconnect it from the mains supply voltage then open the enclosure and use a vacuum cleaner to remove any accumulated dirt and dust. The welder should also be wiped clean. If necessary, solvents that are recommended for cleaning electrical apparatus may be used.

Troubleshooting and repairing of PEGAS welding equipment should only be carried out only by suitably qualified or competent person.

A 'competent person' must be a person who has acquired through training, qualification or experience, or a combination of them, the knowledge and skills enabling that person to safely carry out a risk assessment and repairs to the electrical equipment in question.

The person carrying out the servicing needs and repairs must know what to look at, what to look for and what to do.

9. STATEMENT OF WARRANTY

In accordance with the warranty periods stated below, ALFA IN guarantees the proposed product to be free from defects in material or workmanship when operated in accordance with the written instructions as defined in this operating manual.

ALFA IN welding products are manufactured for use by commercial and industrial users and trained personnel with experience in the use and maintenance of electrical welding and cutting equipment.

ALFA IN will repair or replace, at its discretion, any warranted parts or components that fail due to defects in material or workmanship within the warranty period. The warranty period begins on the date of sale to the end user. If warranty is being sought, please contact your ALFA IN product supplier for the warranty repair procedure.

ALFA IN warranty will not apply to:

Equipment that has been modified by any other party other than ALFA IN's own service personnel or with prior written consent obtained from ALFA IN Service Department.

Equipment that has been used beyond the specifications established in the operating manual.

Installation not in accordance with the installation/operating manual.

Any product that has been subjected to abuse, misuse, negligence or accident. Failure to clean and maintain (including lack of lubrication, maintenance and protection), the machine as set forth in the operating, installation or service manual.

Within this operating manual are details regarding the maintenance necessary to ensure trouble free operation.

👉 NOTE 👉 Warranty repairs must be performed by either an ALFA IN Service Centre, an ALFA IN distributor or an Authorised Service Agent approved by the company ALFA IN.

As a warranty list serves proof of purchase (invoice) on which is the serial number of the machine, eventually a warranty list on the last page of this manual.

10. DISPOSAL



Only for EU countries. Do not dispose of electric tools together with household waste material.

■ In accordance with European Council Directive 2002/96/EC on electrical and electronic equipment waste and its implementation in accordance with national law, electric tools that have reached the end of their service life must be collected separately and returned to an environmentally compatible recycling facility.

11. WARRANTY LIST

As a warranty list serves proof of purchase (invoice) on which is the serial number of the machine, eventually a warranty list below, which is filled in by an authorized dealer.

Serial number:	
Day, month (written in words) and year of sale:	
Stamp and dealer signature:	