

MIG/MAG WELDING MACHINES

**AXE 250 IN MIG MAN
AXE 320 IN MIG MAN**

INSTRUCTION MANUAL

CONTENT:

1. INTRODUCTION	3
2. SAFETY INSTRUCTIONS AND WARNINGS	4
3. CONDITIONS OF USE.....	7
4. TECHNICAL DATA.....	8
5. ACCESSORIES	9
6. DESCRIPTION OF THE APPLIANCE.....	9
7. GETTING STARTED	14
8. WELDING.....	16
9. ROUTINE MAINTENANCE & INSPECTION.....	19
10. STATEMENT OF WARRANTY	21
11. DISPOSAL.....	22
12. WARRANTY LIST	22

1. INTRODUCTION

Congratulations on your new ALFA IN product. We are proud to have you as our customer and will strive to provide you with the best service and reliability in the industry.

This Operating Manual has been designed to instruct you on the correct use and operation of your ALFA IN product. Your satisfaction with this product and its safe operation is our ultimate concern. Therefore please take the time to read the entire manual, especially the Safety Precautions. They will help you to avoid potential hazards that may exist when working with this product.

Read and understand this entire Manual and your employer's safety practices before installing, operating, or servicing the equipment. While the information contained in this Manual represents the Manufacturer's best judgement, the Manufacturer assumes no liability for its use.

AXE 250/320 IN MIG MAN are three phase sturdy welding machines for MIG/MAG welding.

The machines are designed to produce maximum power output combined with high reliability and efficiency.

We reserve the law of adjustments and changes in case of printing errors, change of technical parameters, accessories etc. without previous notice. These changes may not be reflected in the manuals for use in paper or electronic form.



2. SAFETY INSTRUCTIONS AND WARNINGS

1. OPERATION AND MAINTENANCE OF WELDING EQUIPMENT CAN BE DANGEROUS AND HAZARDOUS TO YOUR HEALTH.
2. Arc welding produces intense electric and magnetic emissions that may interfere with the proper function of cardiac pacemakers, hearing aids, or other electronic health equipment. Persons who work near arc welding applications should consult their medical health professional and the manufacturer of the health equipment to determine whether a hazard exists.
3. Once the packing has been opened, make sure that the machine is not damaged. If in any doubt, call the service centre.
4. This equipment must only be used by qualified personnel.
5. During installation, any electric work must only be carried out by trained personnel.
6. The machine must be used in a dry place with good ventilation.
7. Make sure that no metal dust can be drawn in by the fan inside the machine, as this could cause damage to the electronic circuits.
8. It is prohibited to connect more than one generator in series or in parallel.
9. When installing the machine, follow the local regulations on safety.
10. The position of the machine must allow easy access by the operator to the controls and connectors.
11. When the welding machine is operating, all its covers and doors must be closed and well fixed.
12. Do not expose the welding machine to direct sunlight or to heavy rain. This equipment conforms to protection rating IP23S.
13. The operator must wear gloves, clothes, shoes, and a helmet or a welder's helmet, which protect and are fire-resistant in order to protect him against electric shock, flashes and sparks from cutting.
14. The operator must protect his eyes with safety visor or mask designed for welding, fitted with standard safety filters. He should also be aware that during arc welding ULTRAVIOLET RADIATION is emitted. Therefore it is vital that his face is also protected from radiation. Ultraviolet rays produce the same harmful effect as sun burning on unprotected skin.
15. The operator is obliged to warn anyone near the welding area of the risks that welding involves and to arrange to provide adequate protection equipment.
16. Keep all fumes and gases from the breathing area.
17. Keep your head out of the fume plume.
18. Use an air-supplied respirator if ventilation is not adequate to remove all fumes and gases.
19. The kinds of fumes and gases from the plasma arc depend on the kind of metal being used, coatings on the metal, and the different processes. You must be very careful when welding any metals which may contain one or more of the following:

Antimony	Chromium	Mercury
Nickel	Cobalt	Arsenic
Barium	Copper	Selenium
Beryllium	Lead	Silver
Cadmium	Manganese	Vanadium

20. Always read the Material Safety Data Sheets (MSDS) that should be supplied with the material you are using. These MSDSs will give you the information regarding the kind and amount of fumes and gases that may be dangerous to your health.
21. It is very important to arrange for sufficient ventilation, especially when welding in enclosed spaces. We suggest using suitable fume extractors to prevent the risk of intoxication by fumes or gas generated by the welding process.
22. Noise can cause permanent hearing loss. Welding arc processes can cause noise levels to exceed safe limits. You must protect your ears from loud noise to prevent permanent loss of hearing.
23. To protect your hearing from loud noise, wear protective ear plugs and/or ear muffs. Protect others in the workplace.
24. Noise levels should be measured to be sure the decibels (sound) do not exceed safe levels.
25. The operator must ensure all flammable materials are removed from the work area to avoid any risk of fire.
26. The operator must NEVER weld containers that have previously contained petrol, lubricants, gas or similar flammable materials, even if the container has been empty for a considerable time. THERE IS A VERY HIGH RISK OF EXPLOSION.
27. The operator must be aware of all the special regulations which he needs to conform to when cutting in enclosed spaces with a high risk of explosion.
28. To prevent electric shock, we strongly suggest the following rules:
 - a) Do not work in a damp or humid environment.
 - b) Do not use the machine if its cables are damaged in any way.
 - c) Make sure that the earthing system of the electric equipment is correctly connected and operational.
 - d) The operator must be insulated from the metal components connected to the return wire.
 - e) The earthing of the piece being worked could increase the risk of injury to the operator.
29. EN 60974-1 Standard: Open-circuit voltage. During the operation of the machine, the highest voltage, with which it is possible to come into contact, is the open-circuit voltage between the clamps.
30. The maximum open-circuit voltage of the plasma machines is established by national and international standards (EN 60974-1) depending on the type of current to be used, on its waveform and on the hazards arising from the work place. These values are not applicable to

the strike currents and those for stabilisation of the arc that could be above it.

31. The open-circuit voltage, for as many adjustments as possible, must never exceed the values relating to the various cases shown in the following table:

Case	Working conditions	Open-circuit voltage	
1	Places with increased risk of electric shock	DC current: 113V peak value	AC current: 68V peak value and 48V effective
2	Places without increased risk of electric shock	DC current: 113V peak value	AC current: 113V peak value and 80V effective
3	Torches held mechanically with increased protection for the operator	DC current: 141V peak value	AC current: 141V peak value and 100V effective
4	Plasma cutting	DC current: 500V peak value	

32. In case 1, the dc machines with rectifier must be built in such a way that, in case of a fault developing in the rectifier (for example open circuit, short circuit or lack of power), the permitted values cannot be exceeded.

The welding machines of this type can be marked with the symbol: 

33. Before opening the machine switch off the machine and disconnect it from the power socket.
34. Only personnel authorised by this company can carry out maintenance on the machine.

PROTECTIVE UTILITIES

1. Welding helmet with filter shade at least 10
2. Welding gloves
3. Welding apron and cloth
4. Welding boots

RISK OVERVIEW

1. Risk of electric shock.
2. Ultraviolet light and light radiation
3. Risk of inhaling gas fumes and dust particles
4. Burns
5. Noise

NOTE

1. It is forbidden to operate a machine with damaged insulation of the

- welding torch or supply cable.
2. Never operate the machine taken down or damaged covers.
 3. It is forbidden to operate the machine in wet environments and outdoors in rain or snow.
 4. Ensure proper grounding clamping pliers, which also reduces the risk of electric shock.
 5. Use prescribed protective utilities, keep them dry.
 6. Arc welding produces intense electric and magnetic emissions that may interfere with the proper function of cardiac pacemakers, hearing aids, or other electronic health equipment. Persons who work near plasma arc cutting applications should consult their medical health professional and the manufacturer of the health equipment to determine whether a hazard exists.
 7. Never aim the torch against the eyes, body or other person.

3. CONDITIONS OF USE

1. This equipment must only be used by qualified personnel.
2. During installation, any electric work must only be carried out by trained personnel.
3. Device complies with IEC 61000-3-12.
4. Do not expose the plasma machine to direct sunlight or to rain or snow. This equipment conforms to protection rating IP23S.
5. Working ambient temperature between -10 and +40 °C.
6. Relative humidity below 90% at +20 °C.
7. Up to 3000 m altitude.
8. Place the machine the way that the cooling air can enter the vents without restriction to. It is necessary to ensure that no impurities, especially metal particles, are not drawn into the machine.
9. Welding machine in terms of interference suppression is intended primarily for industrial premises. In the case of use of other areas may be need for special measures (see EN 60974-10).
10. The stability of the machine is guaranteed up to 10 ° inclination under the following conditions:
 - a. The machine must be secured against rolling away
 - b. The gas bottle with a maximum height of 0.9 m may be placed and properly anchored on the platform
11. The machine must be protected against
 - a. Moisture and rain and snow
 - b. Mechanical damage
 - c. Draft and any ventilation of neighbouring machine
 - d. Excessive overloading - crossing technical parameters
 - e. Rough handling

ELECTROMAGNETIC COMPATIBILITY

The welding device is in terms of interference designed primarily for industrial areas. It meets the requirements of EN 60974-10 class A and it isn't designed for using in residential areas, where the electrical energy is supplied by public low-voltage power supply network. It can be here potential problems with ensuring of electromagnetic compatibility in this areas, due to interference caused by power lines as well as the radiated interference. During operation, the device may be the source of interference.

 Caution 

We warn users, that they are responsible for possible interference from welding.

4. TECHNICAL DATA

Model		AXE 250 IN MIG MAN	AXE 320 IN MIG MAN
Method		MIG/MAG	MIG/MAG
Mains voltage	V/Hz	3 x 400/50-60	3 x 400/50-60
Welding current range	A	20 - 250	20 - 315
Open-circuit voltage U_{20}	V	54,4	63,1
Mains protection	A	16 @	16 @
Max. effective current I_{1eff}	A	12,9	12,9
Welding current (DC=100%) I_2	A	210	210
Welding current (DC=60%) I_2	A	250	250
Welding current (DC=x%) I_2	A	60%=250	25%=315
Protection		IP 23S	
Standards		EN 60974-1, EN 60974-10 cl. A	
Dimensions (w x l x h) generator	mm	474 x 911 x 670	
Weight - compact/generator	kg	47,6	47,6
Wire speed	m/min	0,5 - 17	0,5 - 17
Spool diameter	mm	300	300
Spool weight	kg	18	18

5. ACCESSORIES

DELIVERED WITH THE MACHINE

1. Earthing cable 3m with a clamp
2. Gas hose
3. Rolls for wire with diameter 0,8 - 1,0 mm
4. Operating manual
5. Reduction for wire coil 5 kg and 15 kg

ACCESSORIES TO ORDER

1. Reduction valve
2. Spare parts for the torch
3. Feed rolls 0,6-0,8 1,0-1,2 for carbon steels, aluminium, flux core wires
4. Torch ABIMIG 305 3 – 5 m
5. Wire cleaner

6. DESCRIPTION OF THE APPLIANCE

MAIN PARTS

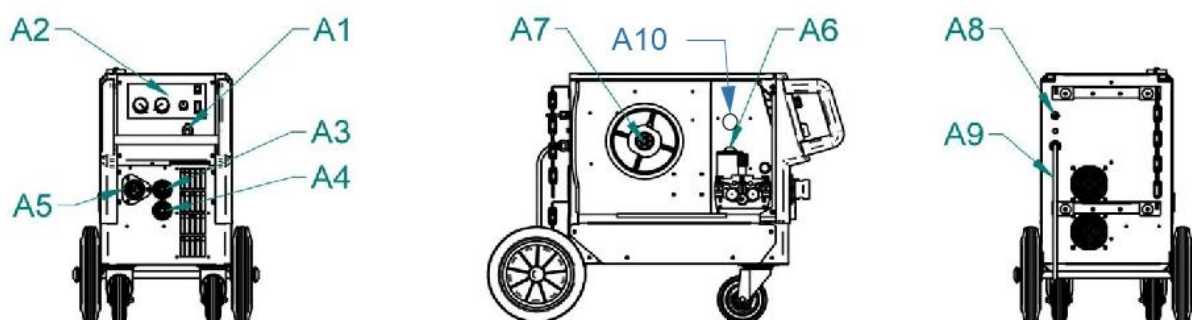

R057-1

Picture 1 - Main parts

A1	On/Off Switch
A2	PCB control panel
A3	Quick Connector + (optional)
A4	Quick Connector -
A5	EURO connector
A6	Wire Feeder
A7	Spool Holder
A8	Solenoid Valve
A9	Mains Cable
A10	Burnback – adjustable wire burn time (0-10 = 0-75 ms) *

*adjustable welding wire burn-out time from torch switch off

CONTROL PANEL

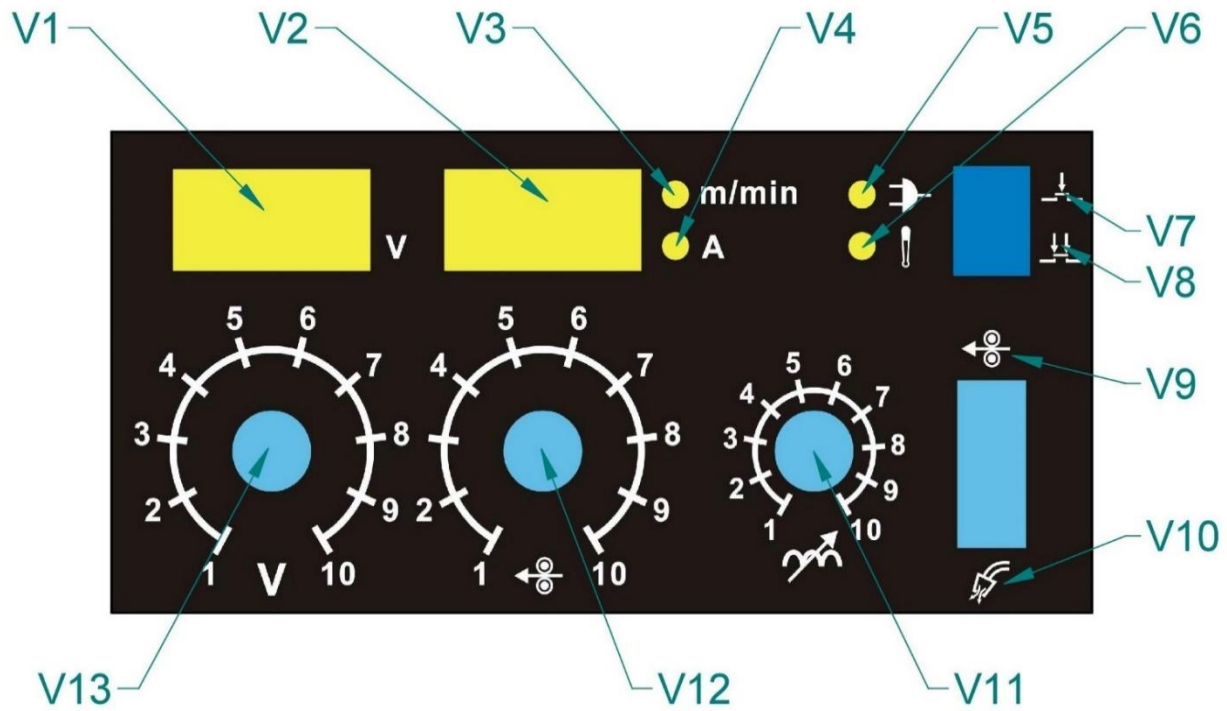

Picture 2 – Control panel

V1	Voltage display
V2	Display shows the welding current the wire feed speed
V3	LED indicator – if illuminated, the display V2 shows the wire speed
V4	LED indicator – if illuminated, the display V2 shows the welding current
V5	LED indicator - if illuminated, the machine is ON
V6	LED indicator – if illuminated, the welder is over heated or the mains voltage is out of range
V7	Position of the switch for the mode two stroke 2T
V8	Position of the switch for the mode four stroke 4T
V9	Position of the switch for the inserting of the wire
V10	Position of the switch for the gas test
V11	Choke potentiometer
V12	Potentiometer of the wire feed speed
V13	Voltage potentiometer

WIRE FEEDER

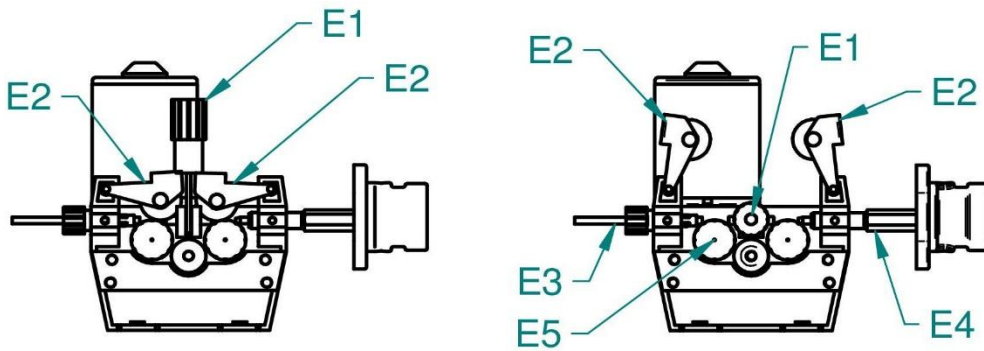

Picture 3 - Wire feeder 4 rolls

E1	Nut of pressure arm
E2	Pressure arm
E3	Inlet liner
E4	EURO connector
E5	Roll

CHOOSING THE FEEDING ROLL

In all machines ALFA IN MIG / MAG rolls with two grooves are used. These grooves are intended for two different wire diameters (e.g. 0,8 and 1,0 mm).

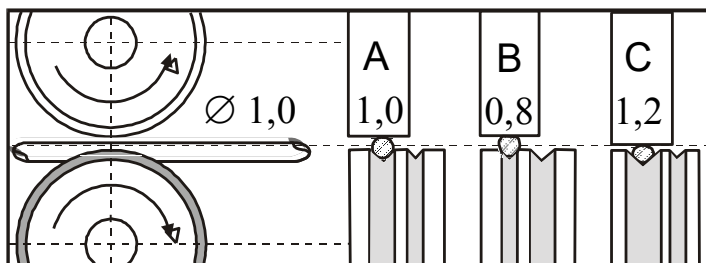

Rolls for wire feed must comply with the diameter and material of the welding wire. Only this way a smooth wire feed can be achieved. Irregularities of the wire feed leads to a poor quality of welding and deformation of the wire.



A	Correct
B	Wrong
C	Wrong

Picture 4 - The influence of the roll groove on the welding wire

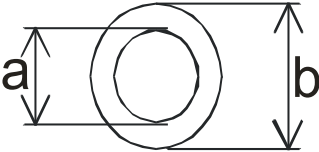
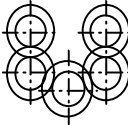
OVERVIEW OF ROLLS FOR WIRE FEED

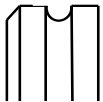
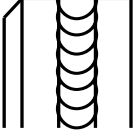
		4 rolls
		
		a = 22 mm
		b = 30 mm
Groove type	Wire diameter	Item No
Steel 	0,6-0,8	2187
	0,8-1,0	2188
	1,0-1,2	2189
Aluminum 	0,8-1,0	2270
	1,0-1,2	2269
Flux core 	0,8-1,0	2318
	1,0-1,2	2319
	1,2-1,4	2320

ADJUSTING THE MACHINE FOR ANOTHER WIRE DIAMETER

In all machines ALFA IN MIG / MAG are used rolls with two grooves. These grooves are intended for two different wire diameters (e.g. 0,8 a 1,0 mm). Groove can be replaced by removing the rolls and rotating them, or use a different roll grooves with required dimensions.

1. Open the nut **E1** to the right, pressure roll **E2** will be opened upward
2. Unscrew the plastic locking element **E5** and remove the roll
3. If there is a suitable groove on the roll, rotate the roll and place it back on the shaft and secure it by screwing the element **E5**.

ADJUSTING THE MACHINE FOR WELDING OF ALUMINIUM

For feeding the AL wire it is necessary to use roll with the "U" profile - see paragraph OVERVIEW ROLLS WIRE FEED. To prevent problems with feeding use wires with diameter. 1.0 mm of AlMg3 or AlMg. Wire of alloy Al99, 5 or AlSi5 are too soft and easily will cause problems with movement.

For the aluminum welding it is also necessary to provide the torch tefl. liner and special current nipple. We do not recommend you to use the torch longer

than 3 m. Great attention must be paid to adjust the contact power of rolls – it must not be too high, otherwise there is a deformation of the wire.

As a protective atmosphere is necessary to use argon.

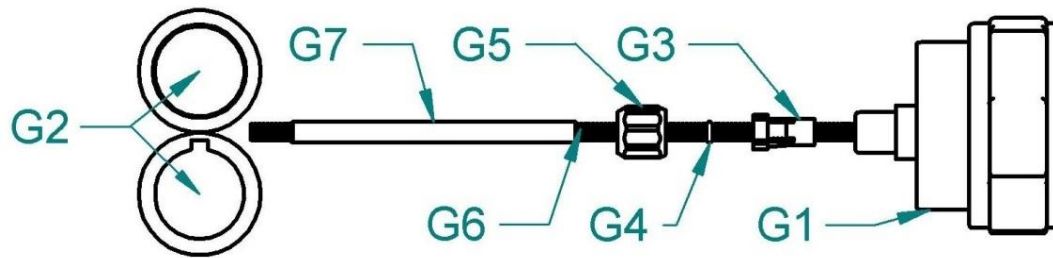

Picture 5 – Customization of the feed for the aluminium wire

G1	EURO connector
G2	Rolls
G3	Liner terminal for 4,0mm, 4,7mm outer diameter
G4	O-ring 3,5 x1, 5mm to prevent escape of gas
G5	Nut
G6	Liner tefl.
G7	Sustain pipe for teflon and plastic liner

INSERTING THE WIRE

1. Open the side cover of the wire feeder space.
2. Put the wire spool on the wire spool holder **D1** and fix it with the fixing nut **D2**. If a spool (size of 15 or 18 kg) is used, put on each side of the spool adapter **D3**. The hole in the back of the adapter must fit into the pin on the wire spool holder!
3. Cut off the curved or damaged end of welding wire and lead it through the inlet liner **E3**, and the roll into the liner inside the EURO torch connector (about 5 cm). Make sure, that you use the suitable groove.
4. Put the pressure arm **E2** down in that way, that the teeth or the gear fit and fix it by setting the lever **E1** into vertical position.
5. Adjust the pressure nut that way that it provides constant movement of wire but it does not deform wire. The adjusting screw is located under the plastic screw **E1**.
6. The spool brake is set by the manufacturer. If necessary, the brake can be adjusted by a screw **D1** so that while stopping the feed, spool will be stopped on time (it will avoid excessive release of wire). However, too tight brake needlessly strains the feeding mechanism and thus slippage may occur in the wire rolls.

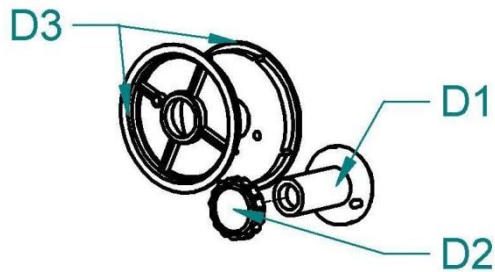

D1	Spool Holder
D2	Nut Spool Holder
D3	Adapter

Picture 6 - Spool holder

ADJUSTING PRESSURE FORCE OF FEED ROLLS

Important thing for reliable operation of the feeding mechanism is the size of pressure force of feed rolls.

The amount of force depends on the type of welding wire, for aluminum or tube wire, we choose a smaller pressure force

If the pressure force is too small, slippage may occur and thus irregular wire feeding speed.

If the pressure force is too high, it will lead to increased mechanical wear of bearings and it can damage the machine. Before putting into operation, clean the rolls from preservative oil.

7. GETTING STARTED

Getting started must be consistent with technical data and conditions of use.

INSERTING THE WIRE TO THE TORCH AND CONNECTION OF EARTH CABLE

1. Connect the earthling clamps to the welder or to the welding table.

👉 Notice 👉 When inserting the wire do not point with torch to the eyes!

2. Screw the central end of the torch **B2** to connector **B1** on the machine while the machine is turned off.
3. Remove the gas nozzle from the torch.
4. Unscrew the current nozzle.
5. Connect the machine to power supply.
6. Turn the main switch on the back panel to ON.
7. Press the lower switch on the control panel into the position for inserting of the wire **V9**. The welding wire is fed into the torch. After coming off from the torch tube, screw the current nozzle and gas nozzle on.
8. Before welding, spray the area in a gas hose and current nozzle with a separation spray, to prevent damage.

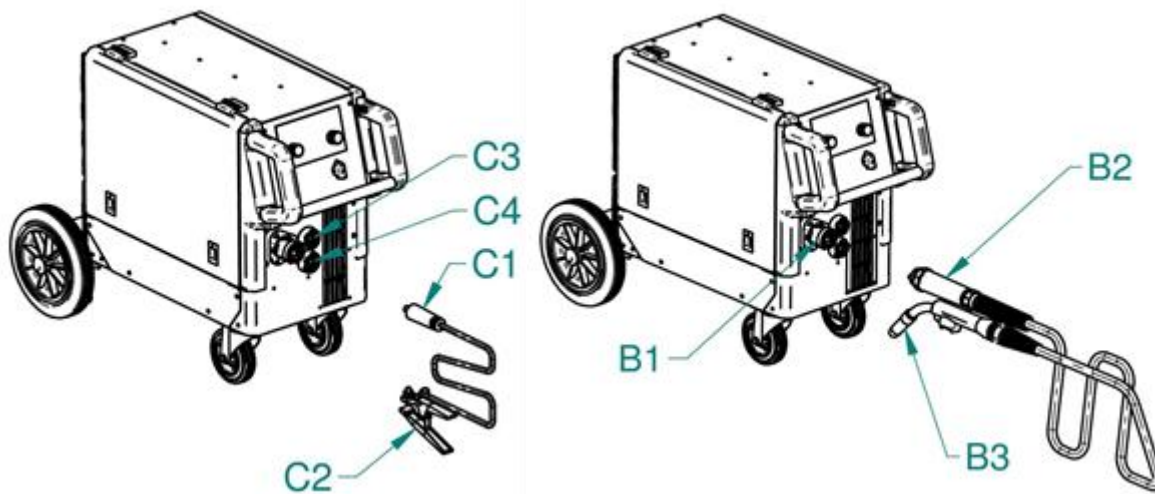

Picture 7 - Connection of torch and earth cable

B1	EURO connector
B2	EURO connector male
B3	Torch
C1	Quick connector male
C2	Earthing clamps
C3	Quick connector (+) (optional)
C4	Quick connector (-)

ADJUSTMENT OF GAS FLOW

The electric arc and the weld must be perfectly shielded by gas. Too small amount of gas does not perform the protective atmosphere and on the other hand to big amount of the gas brings air into the electric arc.

Notice Gas bottle must be well secured against fall. This manual does not solve the safe securing of gas bottle. Information can be obtained from a supplier of industrial gases.

1. Fit the gas hose to the outlet on the back panel of the machine.
2. Press the lower switch on the control panel into the position for gas test **V10** and hold the switch depressed.
3. Turn the adjusting screw **F7** at the bottom side pressure reducing valve, until the meter **F6** shows the required flow, then release the switch. The optimum flow is 10-15l/min.
4. After long-term shutdown of the machine or replacement of the torch it is suitable to blow the pipes with protective gas before welding.

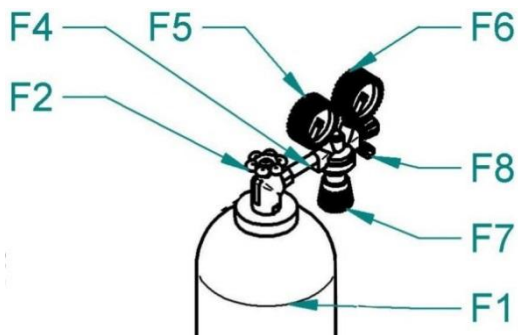

Picture 8 – Gas flow setting

F1	Gas bottle
F2	Cylinder Valve
F4	Pressure Reducer
F5	High Pressure Manometer
F6	Low Pressure Manometer
F7	Adjusting Screw
F8	Gas outlet

8. WELDING

WELDING VOLTAGE

When the wire had been installed and gas had been set it is possible to start welding.

The appliance must be plugged into the mains, the ON/OFF switch on "I". You will find the ON/OFF switch on the rear panel of the welder.

To select the voltage use the potentiometer **V13**.

WELDING CURRENT

Size of the welding current depends on the wire feed speed and voltage.

To select the current use the potentiometer **V12**.

Characteristic of the curve ("hardness / softness") can be controlled by correction of the choke **V11**.

Approximate setting for the MIG / MAG welding current and voltage corresponds the empirical relationship $U_2 = 14 + 0.05 I_2$. According to this relationship, we can determine the required voltage. When setting the voltage, we expect the decline in voltage during load. The voltage drop is approximately 4.5-5.0 V at 100 A.

Set the welding current by setting the welding voltage first and then configure the wire feed speed to the point, where the burning of the arc is ideal.

Please note that the actual settings for ideal arc may vary slightly depending on the position of the weld material and voltage fluctuations.

To achieve a good quality of the welds and the optimum setting of the welding current it is necessary to ensure that the distance of the power nozzle from the material was about 10 times the diameter of the welding wire.

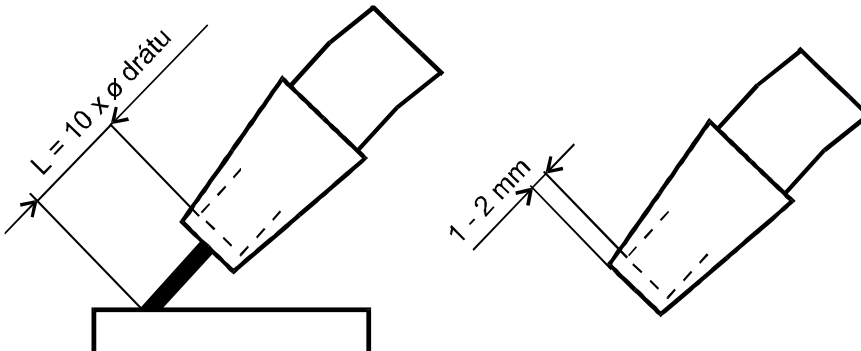

Picture 9 – Distance from nozzle to material

WELDING MODES

Machines works in two modes:

- continuous two stroke (2T)
- continuous four stroke (4T)

To select the mode switch the 2T/4T switch into the appropriate position.

WELDING MODE – TWO STROKE

Press the top switch on the control panel into the position **V7**. Welding procedure starts by pressing the button in the torch handle. It is necessary to keep the button pressed all the time during welding. The welding stops by releasing the torch button.

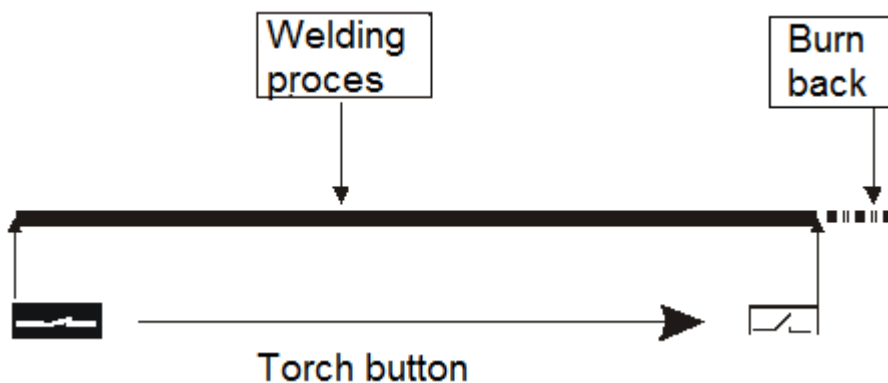

WELDING MODE - FOUR STROKE

Press the top switch on the control panel into the position **V8**. The welding procedure starts by pressing the torch button; after releasing the torch button the welding continues. The welding stops after the second pressing and releasing the torch button then.

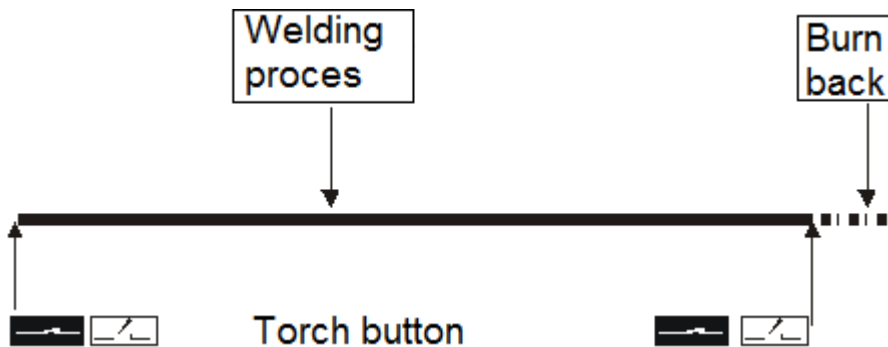

TABLE OF WIRE CONSUMPTION DURING WELDING

Wire diameter [mm]	Range of wire feed speed [m/min]	Maximal wire feed speed [m/min]	Weight of 1 m wire [g]	Wire consumption per 1 minute of welding [g/min]	Wire consumption per 1 hour of welding [g/hour]
Steel wire					
0,6	2 - 5	5	2,3	11,5	690
0,8	3 - 6	6	4	24	1440
1,0	3 - 12	12	6	72	4320
1,2	4 - 18	18	9	162	9720
Stainless steel wire					
0,6	2 - 5	5	2,3	11,5	690
0,8	3 - 6	6	4	24	1440
1,0	3 - 12	12	6	72	4320
1,2	4 - 18	18	9	162	9720
Aluminum wire					
0,6	2 - 5	5	0,8	4	240
0,8	3 - 6	6	1,3	7,8	468
1,0	3 - 12	12	2	24	1440
1,2	4 - 18	18	3	54	3240

TABLE OF GAS CONSUMPTION DURING WELDING

Wire diameter [mm]	Gas flow [l/min]	Gas consumption per 1 hour of welding [l/hour]
0,6	6	$6 * 60 = 360$
0,8	8	$8 * 60 = 480$
1,0	10	$10 * 60 = 600$
1,2	12	$12 * 60 = 720$
1,6	16	$16 * 60 = 960$
2,0	20	$20 * 60 = 1200$

9. ROUTINE MAINTENANCE & INSPECTION

1. The only routine maintenance required for the AXE range of machines is a thorough cleaning and inspection, with the frequency depending on the usage and the operating environment.

 **WARNING** 

2. Disconnect the AXE from the mains supply voltage before disassembling.
3. Special maintenance is not necessary for the control unit parts in the Welder. If these parts are damaged for any reason, replacement is recommended.

 **CAUTION** 

4. Do not blow air into the welder during cleaning. Blowing air into the welder can cause metal particles to interfere with sensitive electronic components and cause damage to the welder.
5. To clean the welder, disconnect it from the mains supply voltage then open the enclosure and use a vacuum cleaner to remove any accumulated dirt and dust. The welder should also be wiped clean. If necessary, solvents that are recommended for cleaning electrical apparatus may be used.
6. Troubleshooting and repairing of AXEwelding equipment should only be carried out only by suitably qualified or competent person.
7. A 'competent person' must be a person who has acquired through training, qualification or experience, or a combination of them, the knowledge and skills enabling that person to safely carry out a risk assessment and repairs to the electrical equipment in question.
8. The person carrying out the servicing needs and repairs must know what to look at, what to look for and what to do.

TROUBLE SHOOTING

Symptom	Reason	Solution
The torch is too hot	Nozzle is not fixed.	Tighten the nozzle
Button on the torch does not respond	Connectivity of EURO connector is loose	Tighten EURO connector
	Damaged wiring in the torch	Check and replace if necessary.
Irregular wire feed or wire is caked to the nozzle.	The wire on the spool is too tightly wound.	Check and replace the spool if necessary.
	The ball is fused to the nozzle.	Cut out the ball and piece of the wire at the beginning.
Irregular or no wire feed.	Poor pressure in the wire feed rolls	Adjust the pressure according to this instruction manual.
	The torch is damaged.	Check and replace if necessary.
	The groove on the feed roll does not correspond to the welding wire diameter.	Put the correct roll.
	Bad quality of the wire.	Check and replace if necessary.
	The liner in the torch is unclean or damaged.	Check and replace if necessary
	Spool brake is badly configured.	Adjust it according to this instruction manual.
Arc or short circuit between the hose and the nozzle	Glued spatter inside the gas nozzle.	Remove the spatter.
Unstable arc	Incorrect diameter of the nozzle or too worn out or damaged nozzle.	Change the nozzle.
Inadequate supply of a protective gas, pores in the weld	Poorly set the amount of supplied gas.	Set the correct amount as described in this instruction manual.
	Reducing valve on the bottle is dirty	Check and replace if necessary.
	The torch or gas hoses are dirty	Check and replace if necessary.
	Protective gas is blown away by draft.	Stop the draft

Bad welding power	Missing phase.	Try to connect the machine to a different outlet. Check the power supply cable and circuit breaker.
	Poor grounding.	Ensure the best connection between the work piece and the earthing cable / clamps of the machine.
	The grounding cable is poorly attached to the connector on the machine.	Tighten the earthing cable in the connector on the machine.
	Torch damaged	Check and replace if necessary.
During feeding welding wire is rubbed.	The groove on the feed roll does not correspond to the welding wire diameter.	Put the correct roll.
	Wrong pressure in the upper wire feed roll	Adjust the pressure according to this instruction manual.

10. STATEMENT OF WARRANTY

1. In accordance with the warranty periods stated below, ALFA IN guarantees the proposed product to be free from defects in material or workmanship when operated in accordance with the written instructions as defined in this operating manual.
2. ALFA IN welding products are manufactured for use by commercial and industrial users and trained personnel with experience in the use and maintenance of electrical welding and cutting equipment.
3. ALFA IN will repair or replace, at its discretion, any warranted parts or components that fail due to defects in material or workmanship within the warranty period. The warranty period begins on the date of sale to the end user.
4. If warranty is being sought, please contact your ALFA IN product supplier for the warranty repair procedure.
5. ALFA IN warranty will not apply to:
 - a) Equipment that has been modified by any other party other than ALFA IN's own service personnel or with prior written consent obtained from ALFA IN Service Department.
 - b) Equipment that has been used beyond the specifications established in the operating manual.

- c) Installation not in accordance with the installation/operating manual.
 - d) Any product that has been subjected to abuse, misuse, negligence or accident.
 - e) Failure to clean and maintain (including lack of lubrication, maintenance and protection), the machine as set forth in the operating, installation or service manual.
6. Within this operating manual are details regarding the maintenance necessary to ensure trouble free operation.

**NOTE**

Warranty repairs must be performed by either an ALFA IN Service Centre, an ALFA IN distributor or an Authorised Service Agent approved by the company ALFA IN.

- 7. As a warranty list serves proof of purchase (invoice) on which is the serial number of the machine, eventually a warranty list on the last page of this manual.

11. DISPOSAL



Only for EU countries. Do not dispose of electric tools together with household waste material.

In accordance with European Council Directive 2002/96/EC on electrical and electronic equipment waste and its implementation in accordance with national law, electric tools that have reached the end of their service life must be collected separately and returned to an environmentally compatible recycling facility.

12. WARRANTY LIST

As a warranty list serves proof of purchase (invoice) on which is the serial number of the machine, eventually a warranty list below, which is filled in by an authorized dealer.

Serial number:	
Day, month (written in words) and year of sale:	
Stamp and dealer signature:	